

Off Grid Solar Inverter Charger

User's Manual

(4KW - 12KW 48Vdc 120/240Vac Split Phase)

Version 1.0 (PN:80000-20220923)



ETL Listed to UL1741 CSA22.2

Manufacturer Information

Sigineer Power Limited

Email: info@sigineer.com / TEL: +86 769 82817616

US Warehouse: 4415 S 32nd St, Phoenix AZ 85040

WhatsApp: +86 18998080464

Table of Contents

1 Important Safety Information	3
1.1 General Safety Precautions	3
1.2 Precautions When Working with Batteries	4
1.3 Target Group	4
1.4 UL17141 & CSA22.2 Certificates	4
2 Introduction	7
2.1 General Information	7
2.2 Mechanical Drawing	7
2.3 Features	10
2.4 Electrical Performance	10
2.4.1 Invert	10
2.4.2 AC & MPPT Charger	11
2.4.3 DC&AC Transfer	14
2.4.4 Power Saver	14
2.4.5 Protections	15
2.4.6 Remote Monitoring	15
2.4.7 LCD & Specification Setup	17
2.4.8 Audible Alarm	29
2.4.9 FAN Operation	29
2.4.10 Automatic Generator Start	30
2.4.11 Automatic Recovery Operation	30
2.4.12 Other Features	31
3 Installation	31
3.1 Location	31
3.2 Unpacking and Inspection	31
3.3 Battery Wiring	31
3.4 PV Wiring	33
3.5 AC Wiring	33
3.6 Communication With Lithium Batteries	35
3.7 Communication With Computer	36
3.8 Grounding	36
3.9 Mounting Flange	36
4 Maintenance & Troubleshooting	37
5 Warranty	39
Appendix 1 : M Series Inverter/Charger Spec Sheet	40
Appendix 2: M Series Inverter/Charger System Wiring Diagram	43
Appendix 3: UL1741 & CSA22.2 Certificates	43

Please record the Sigineer Power unit’s model and serial number in case you need to provide this information in the future. It is much easier to record this information now than try to gather it after the unit has been installed.

Order Number: _____
Model Number: _____
Serial Number: _____

1 Important Safety Information

Save This Manual! Read this manual before installation, it contains important safety, installation and operating instructions. Keep it in a safe place for future reference.

All wiring must follow the National Electric Code, Provincial or other codes in effect at the time of installation, regardless of suggestions in this manual. This off grid solar inverter should be connected to a grounded wiring system. If the system ground is floating, please follow the codes in effect.

MISTAKES TO AVOID

- 1 Don't reverse the DC reverse the battery or PV terminal polarity.**
- 2 Don't use any third-party accessories, communication cables on the inverter.**
- 3 Don't wire the AC cables wrong.**
- 4 Don't install the inverter without AC input surge protection device (SPD) or lightning protection.**
- 5 Don't use the inverters with any types of lithium batteries without BMS.**

1.1 General Safety Precautions

1.1.1 Before installing and using the M Series Off Grid Solar Inverter Charger, please read the manual and cautionary markings on the Inverter/Charger enclosure. Be sure to read all instructions and cautionary markings for any equipment attached to this unit. Installers must be certified technicians or electricians.

1.1.2 This product is designed for indoor/compartment installation. Do not expose the inverter/charger to rain, snow, spray, bilge or dust. To reduce the risk of hazard, do not cover or obstruct the ventilation openings. Do not install the inverter/charger in a zero-clearance compartment. Overheating may result. Allow at least 30CM (11.81 inches) of clearance around the inverter for air flow. Make sure that the air can circulate freely around the unit. A minimum air flow of 145CFM is required to prevent overheating.

1.1.3 To avoid a risk of fire and electronic shock. Make sure that any user installed wiring is in good electrical condition and is not undersized. Do not operate the inverter with damaged or substandard wiring. Consult a professional or your local codes for acceptable wire size to carry the necessary voltage for the installation and intended usage.

1.1.4 This equipment contains components which can produce arcs or sparks. To prevent fire or explosion do not install in compartments containing batteries or flammable materials or in locations which require ignition protected equipment. This includes any space containing gasoline-powered machinery, fuel tanks, or joints, fittings, or other connection between components of the fuel system. See the Warranty section in the manual for instructions on obtaining service.

1.1.5 Do not dis-assemble the Inverter/Charger. **IT CONTAINS NO USER SERVICEABLE PARTS.** Attempting to service the Inverter/Charger yourself may result in a risk of electrical shock or fire. Internal capacitors remain charged after all power has been disconnected.

1.1.6 To reduce the risk of electrical shock, disconnect both AC and DC power from the Inverter/Charger before attempting any maintenance or cleaning. Turning off the inverter power switch will not reduce this risk.

CAUTION: Equipment damage

The output side of the inverter's AC wiring should at no time be connected to public power or a generator. This condition is far worse than a short circuit. If the unit survives this condition, it will shut down until corrections are made.

Installation should ensure that the inverter's AC output is, at no time, connected to its AC input.

WARNING: LIMITATIONS ON USE

PLEASE NOTE THAT THE INVERTER/CHARGER SHOULD NOT BE USED IN CONNECTION

WITH LIFE SUPPORT SYSTEMS OR OTHER MEDICAL EQUIPMENT OR DEVICES. WE MAKE NO WARRANTY OR REPRESENTATION IN CONNECTION WITH THEIR PRODUCTS FOR SUCH USES. USING THE INVERTER/CHARGER WITH THESE PARTICULAR EQUIPMENTS IS AT YOUR OWN RISK.

1.2 Precautions When Working with Batteries

1.2.1 If battery acid contacts skin or clothing, wash immediately with soap and water. If acid enters eye, immediately flood eye with running cold water for at least 20 minutes and seek medical attention immediately.

1.2.2 Never smoke or allow an open spark or flame in the vicinity of battery or engine. When batteries are being recharged, they generate hydrogen gas that is explosive in certain concentrations in air (explosive limits are 4.1 to 72 percent hydrogen in air). The ventilation system can exchange an adequate amount of fresh air for the number of batteries being charged. This is essential to prevent an explosion.

1.2.3 Do not allow metal objects to contact the battery terminals. The resulting spark or short-circuit on the battery or other electrical part may cause an explosion.

1.2.4. Remove personal metal items such as rings, bracelets, necklaces, and watches when working with a lead-acid battery. A lead-acid battery produces a short-circuit current high enough to weld a ring or the like to metal, causing a severe burn.

1.2.5 To reduce the risk of injury, charge only rechargeable batteries suitable for use by this inverter such as deep-cycle lead acid, lead antimony, lead calcium gel cell, absorbed mat, NiCad/NiFe or Lithium battery. Other types of batteries may burst, causing personal injury and damage. NEVER charge a frozen battery. See battery type of this manual for more information about acceptable battery types and program settings.

1.2.6 Don't install the inverter near batteries, the inverter may heat battery electrolyte and cause corrosive fumes to vent and damage/corrode nearby electronics or metals.

1.3 Target Group

This document is intended for qualified persons and end users. Tasks that do not require any particular qualification can also be performed by end users. Qualified persons must have the following skills:

- Knowledge of how an inverter works and is operated
- Training in how to deal with the dangers and risks associated with installing and using electrical devices and installations
- Training in the installation and commissioning of electrical devices and installations
- Knowledge of the applicable standards and directives
- Knowledge of and compliance with this document and all safety information

1.4 UL17141 & CSA22.2 Certificates

The M4048DUL/M5048DUL/M6048DUL/M8048DUL/M10048DUL/M12048DUL inverter models are ETL listed to below standards:

- Inverters, Converters, Controllers and Interconnection System Equipment for use with Distributed Energy Resources [UL 1741:2010 Ed.2+R:16Sep2020]
- Power Conversion Equipment [CSA C22.2#107.1:2016 Ed.4]

The Sigineer Power ETL control number is 5023256.

Our ETL certificate can be verified in “Intertek Directory of Listed Products Search” from the below link:
<https://ramuk.intertekconnect.com/WebClients/ITS/DLP/products.nsf>



1. Find the Company Name on the product label.

Display: LCD+LED
 Communication: WI-FI/GPRS (Optional)
 Operating Temperature Range:0°C~50°C/32°F~122°F

Conforms to UL STD. 1741
 Certified to CSA STD. C22.2 No.107.1

Dongguan Sigineer Power Electrical Technology CO.,LTD.
 +8676982817616
 +8618998080464(WhatsApp)
www.sigineer.com Made In China

2. Verify it on <https://ramuk.intertekconnect.com/WebClients/ITS/DLP/products.nsf>

intertek Total Quality. Assured. Intertek Directory of Listed Products Search

Search Search by: All Limit: No Limit

Sort search results by: Relevance Fuzzy Search

Company	Title	Standard
<input type="checkbox"/> DONGGUAN SIGINEER POWER ELECTRICAL TECHNOLOGY CO., LTD. - Dongguan, Guangdong, CHINA	GENERAL USE POWER SUPPLIES	CAN/CSA-C22.2 No. 107.1
<input type="checkbox"/> DONGGUAN SIGINEER POWER ELECTRICAL TECHNOLOGY CO., LTD. - Dongguan, Guangdong, CHINA	INVERTERS, CONVERTERS & CONTROLLERS & INTERCONNECTION SYSTEM EQUIPMENT	UL-1741

2 results found

Contact Us

ETL listed products that are in doubt or for products that do not appear in the directory, please request a verification of certification.
 Email: ETLValidations@intertek.com

- ▶ Intertek Home
- ▶ Product Directories
- ▶ DLP on mobile devices

Inspector Center

Get up-to-date information on everything from our Accreditations to our

3. A valid ETL certificate will show the Title, Company & Product Information.

intertek
Total Quality. Assured.

ETL US C Intertek | entela Certified | Intertek | DUEGA POINT LABORATORIES US

[-< Back](#) **Product Description**

Title: INVERTERS, CONVERTERS & CONTROLLERS & INTERCONNECTION SYSTEM EQUIPMENT

Company: DONGGUAN SIGINEER POWER ELECTRICAL TECHNOLOGY CO., LTD. - Dongguan, Guangdong CHINA

Product Information: Trade Name(s): Sigineer Power.

PV Off-grid inverter, Model Nos. M4048DUL, M5048DUL, M6048DUL, M8048DUL, M10048DUL, M12048DUL.

Evaluated to the following: A representative sample of the listed devices have been tested, investigated and found to comply with the requirements of the Standard(s) for Inverters, Converters, Controllers & Interconnection System Equipment for Use With Distributed Energy Resources (UL-1741) and are identified with the ETL Listed Mark.

Contact Us
ETL listed products that are in doubt or for products that do not appear in the directory, please request a verification of certification.
Americas+1-888-347-5478 (or +1-847-660-7407)
Email etldirectory@intertek.com

- ▶ Intertek Home
- ▶ Product Directories
- ▶ DLP on mobile devices

4. Ask for the certificate and test report from the seller.

intertek AUTHORIZATION TO MARK

Report No. 220314533ZU-001 Page 3 of 56 Issued: 29-Mar-2022
Dongguan Sigineer Power Electrical Technology Co., Ltd. Revised: 16-May-2022

Product Photographs

Photo 1 - Front, bottom and side view of model M12048DUL (representative sample of model M6048DUL, M10048DUL, M12048DUL)

Photo 2 - Top and side view of model M12048DUL

Applicant: Dongguan Sigineer Power Electrical Technology Co., Ltd.
Address: Room 208, #1 Building, # 2 Hengdong 2nd Road, Hengkeng, Liaobu Town, Dongguan City, Guangdong, 523413
Country: China

Applicant: Dongguan Sigineer Power Electrical Technology Co., Ltd.
Room 208, #1 Building, # 2 Hengdong
Address: 2nd Road, Hengkeng, Liaobu Town, Dongguan City, Guangdong, 523413
Country: CHN

Party Authorized To Apply Mark: Same as Manufacturer
Report Issuing Office: Intertek, Testing Service

Control Number: 5022256 Authorized by:

Standards: Inverters, Converters, Controllers and Interconnection System Equipment for use with Distributed Energy Resources (IEC 1743:2013 Ed. 2+AC 16Sep2020)
Power Conversion Equipment (CSA C22.38.107.1 2016 Ed.4)

Product: #1 Off-grid inverter
Brand Name: Sigineer Power
Models: M4048DUL, M5048DUL, M6048DUL, M8048DUL, M10048DUL, M12048DUL

ATM for Report 220314533ZU-001 Page 1 of 1 ATM Issued: 18-May-2022

Note: Any declared ETL certificate that can't be verified in this way is FAKE.

Please contact us at support@sigineer.com if you have further questions.

2 Introduction

2.1 General Information

Thank you for purchasing the M series Off Grid Solar Inverter/Charger.

The M Series Transformer Based Off Grid Solar Inverter/Charger is a combination of 4 products:

1. **Transformer based DC to AC power inverter**
2. **AC to DC battery charger**
3. **MPPT Solar Charger Controller**
4. **High Speed DC/AC Transfer Switch (10ms).**

Packed with unique features, it is one of the most technically advanced off grid solar inverters on the market. Some solar inverters on the market physically include a solar charger which has no communication with the PCBs of the inverter. The electronically integrated MPPT charge controller we have integrated into this inverter's design is also able to harvest the PV production from your panels to charge the batteries even when the inverter is powered off.

The inverter's powerful DSP (digital signal processor) makes the M series solar inverters very versatile and almost all of its specifications can be adjusted via its LCD, such as AC output voltage, frequency, power priority, low/high battery cutoff, charging profiles & amperage, etc.

- It outputs two hot lines of 120/240vac simultaneously, between each hotline and neutral, it is 120Vac, between two hotlines, it is 240Vac. You can get the full power on 240Vac and half power on each of the hotlines.
- It supports different types of remote monitoring with Remote LCD Panel (Sold separately), Wi-Fi or GPRS module or computer.
- The BMS port communicates with lithium battery for optimal operation of batteries.
- It also has a programmable "US2" setting which works with lithium batteries without BMS communication with the inverter.
- The 300% surge capacity of 5 seconds makes it possible to support demanding inductive loads.
- The M Series models are available in 230Vac (single phase) and 120/240 Vac(split phase), together with a manual 50Hz/60Hz frequency switch, the product line is compatible with all the major utility standards worldwide.

Thus the M Series Pure Sine Wave Inverter/Charger is suitable for a myriad of applications including renewable energy systems, utility, truck, RV and emergency vehicles etc.

To get the most out of the power inverter, it must be installed, used and maintained properly. Please read the instructions in this manual before installing and operating.

2.2 Mechanical Drawing

For 4-6KW

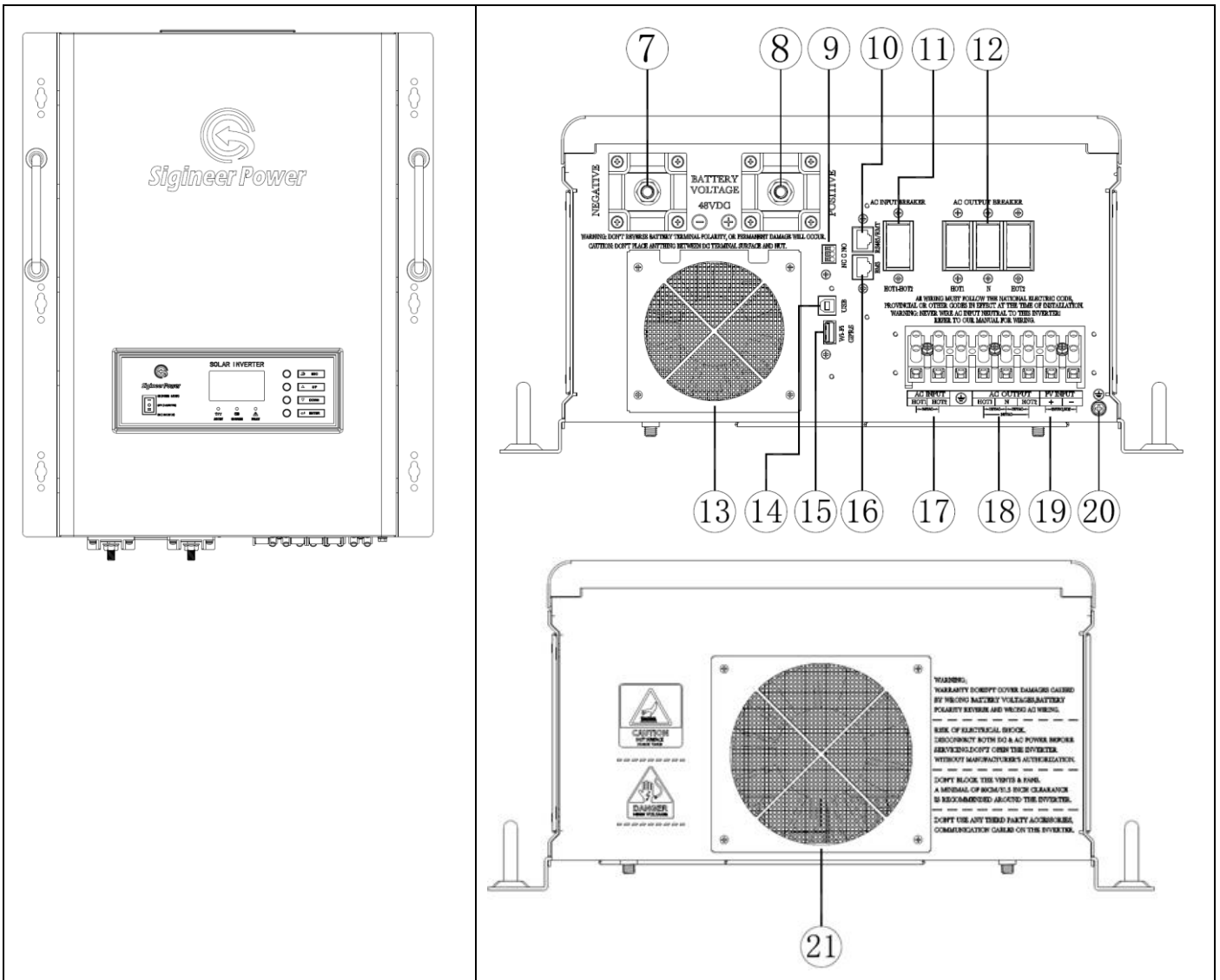

For 8-12KW

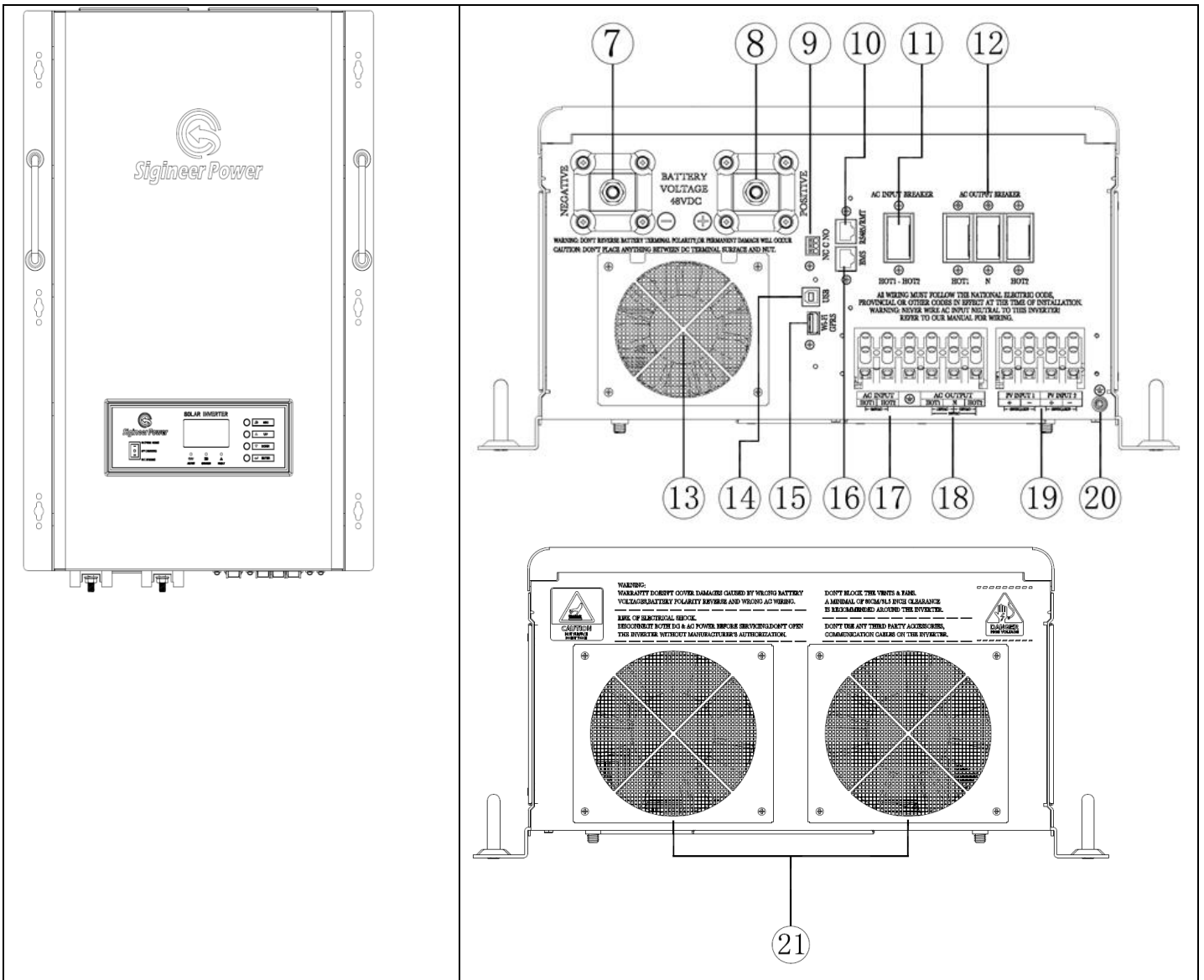

LCD Display

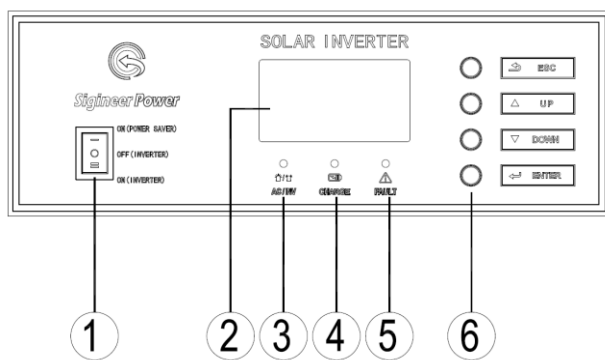

1. ON/OFF Power Switch	2. LCD Display
3. Status Indicator	4. Charging Indicator
5. Fault Indicator	6. Function Buttons
7. Negative Battery Terminal	8. Positive Battery Terminal
9. Dry Contact For AGS	10. RS485/Remote Panel Port
11. AC Input Breaker	12. AC Output Breaker
13. DC Fan	14.USB Port (Connects To Computer)
15. Wi-Fi/GPRS Remote Module Port	16. BMS Port

17. AC Input Terminal	18. AC Output Terminal
19. PV Input Terminal	20. Grounding Terminal
21. AC Fan	

2.3 Features

- *Automatic Solar Charging When the Inverter is Powered Off
- *Auto Generator Start
- *Smart remote monitor with Wi-Fi or GPRS Module
- *Manual 50Hz/60Hz output frequency switch for worldwide operation
- *Maximum THD: 3% at nominal battery voltage
- *Powerful 4-stage power factor corrected battery charger up to 100 Amps, settable from 10A-100A
- *High surge output capability, 300% peak load for 5 seconds
- *Ultra-low quiescent current, low power ‘Power Saver Mode’ to conserve energy
- *Equalization Charging
- *10ms transfer time from AC to battery for the continuous load operation
- *Thermally controlled variable speed fan for more efficient cooling
- *Extensive protections against various harsh situations
- *Solar Priority or SBU developed for renewable energy systems

2.4 Electrical Performance

2.4.1 Invert

Topology

The M Series pure sine wave inverter/charger is built according to the following topology.

- Invert: Full Bridge Topology.
- Charge: Isolated Boost Topology

When operating in invert mode, the direct current (DC) that enters the inverter from the batteries is filtered by a large input capacitor and switched “On” and “Off” by the Metal Oxide Silicon Field Effect Transistors (MOSFET) at a rate of 50 Hz or 60Hz and directed into the transformer which steps the voltage up to 230 or 120 volts. The unit has a powerful microprocessor to control the output voltage and frequency as the DC input voltage and/or output load varies.

Because of high efficiency MOSFETs and the heavy transformers, it outputs PURE SINE WAVE AC with an average THD of 7% (min 3%, max 10% under full linear loads) depending on the load connected and battery voltage.

The peak invert efficiency of M Series is 85%.

The inverter must be connected to batteries to power on.

Overload Capacity

- 1 For 100% < Load < 120%, Fault (Power off) after 10 seconds.
- 2 For 120% < Load ≤ 300%, Fault (Power off) after the 5 seconds.

Soft Start in Inverter Mode

When the inverter is turned on, the output voltage gradually ramps up from 0VAC to rated voltage in about 1.2 sec. This effectively reduces otherwise very high starting inrush current drawn by AC loads such as Switched Mode Power Supplies and inductive loads. This will result in lower motor inrush current, which means less impact on the loads and inverter.

Caution:

After the inverter is switched on, it takes a finite amount of time to self-diagnose and get ready to deliver full power. Always switch on the load(s) after a few seconds of switching on the inverter. Avoid switching on the inverter with the load already switched on. This may prematurely trigger the overload protection. When a load is switched on, it may require an initial higher power surge to start. If multiple loads are being powered, they should be switched on individually so that the inverter is not overloaded by the higher starting surge.

2.4.2 AC & MPPT Charger

The M Series pure sine wave inverter/charger is equipped with an active PFC (Power Factor Corrected) multistage battery charger. The PFC feature controls the amount of power used to charge the batteries in order to obtain a power factor as close as possible to 1.

Unlike other inverters whose max charging current decreases according to the input AC voltage, the M Series pure sine wave inverter/charger is able to output maximum charging current as long as input AC voltage is in the range of 154~260VAC, and AC frequency is in the range of 48-54Hz(58-64Hz for 60Hz model).

The M Series pure sine wave inverter/charger has a very rapid charge current available, and the max charge current can be adjusted from zero to 100% in small increments on the inverter's LCD. This is helpful if this powerful charger applies charging to a small capacity battery bank.

There are three main charging stages:

Bulk Charging: This is the initial stage of charging. While Bulk Charging, the charger supplies the battery with controlled constant current. The charger will remain in Bulk charge until the Absorption charge voltage (determined by the Battery Type selection) is achieved.

A software timer will measure the time from charger start until the battery charger reaches 0.3V below the boost voltage, then take this time as T_0 and $T_0 \times 10 = T_1$.

Absorb Charging: This is the second charging stage and begins after the absorb voltage has been reached. Absorb Charging provides the batteries with a constant voltage and reduces the DC charging current in order to maintain the absorb voltage setting.

In this period, the inverter will start a T_1 timer; and the charger will keep the boost voltage in Boost CV mode until the T_1 timer has expired. The voltage will then be reduced to the float voltage setting. The timer has a minimum setting of 1 hour and a maximum setting of 12 hours. When charging current falls below 0.01C, the charger will switch to the float charge.

Float Charging: The third charging stage occurs at the end of the Absorb Charging time. While Float charging, the charge voltage is reduced to the float charge voltage (determined by the Battery Type selection*). In this stage, the batteries are kept fully charged and ready if needed by the inverter.

If the battery type is selected as "lithium battery", our charger will drastically reduce the charging current to zero once float voltage is reached.

Battery Charging Processes

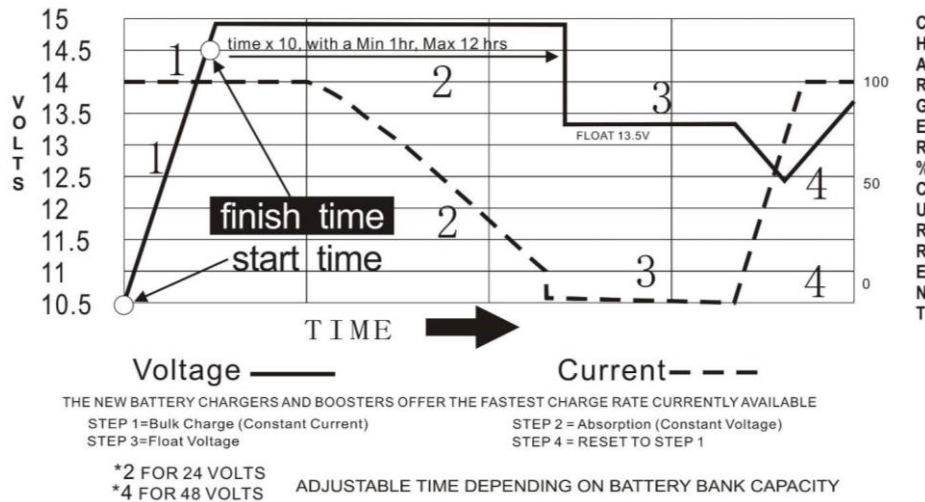

When the AC power charging process starts, the charging current will each peak in around 3 seconds, the charger may overload the AC input generator and drop its output frequency, making inverter switch to battery mode.

It is suggested to gradually put charging load on the generator by switching the charging switch from minimum to maximum, and give the generator enough time to spin up.

	<p>To guarantee the best performance of the AC charger when the AC input is from a generator, the standby generator should be rated at least 150% higher capacity than the inverter.</p> <p>Warning! Operation with an under-rated generator or generator with unqualified wave form may cause premature failure which is not under warranty.</p>
--	---

Battery Equalization

The equalization function has been added into the M series inverter charge controller. It reverses the buildup of negative chemical effects like stratification, a condition where acid concentration is greater at the bottom of the battery than at the top. Equalization also helps to remove sulfate crystals that might have built up on the plates. If left unchecked, this condition, called sulfation, and will reduce the overall capacity of the battery. Therefore, it's recommended to equalize battery periodically.

How to Apply Equalization Function

You must enable battery equalization function in monitoring LCD setting program 23 first. Then, you may apply this function in device by either one of following methods:

1. Set equalization interval in program 27.
2. Active equalization immediately in program 28.

When to Equalize

In float stage, when the equalization interval setting (battery equalization cycle) has arrived, or equalization is active immediately, the controller will start to enter the Equalize stage.

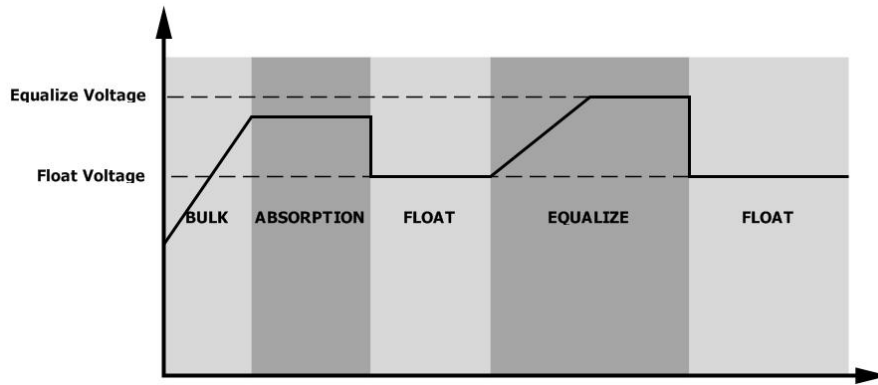

Equalize charging time and timeout

In the Equalize stage, the controller will supply power to charge the battery as much as possible until the battery voltage raises to battery equalization voltage. Constant-voltage regulation is then applied to maintain battery voltage at the battery equalization voltage. The battery will remain in the Equalize stage until the set battery equalization time has come.

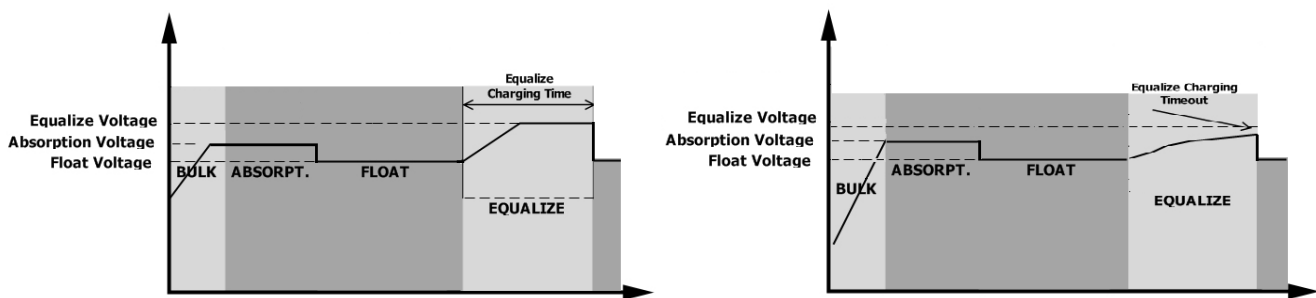

However, in the Equalize stage, when battery equalization time has expired and battery voltage has not risen to the battery equalization voltage point, the charge controller will extend the battery equalization time until the battery voltage achieves battery equalization voltage. If the battery voltage is still lower than battery equalization voltage when battery equalization timeout setting has been reached, the charge controller will stop equalization and return to float stage.

The M Series pure sine wave inverter/charger is built with MPPT solar charging modules up to 120A.

Model #	AC Charging Current	MPPT Solar Charger	Max Charging Current
M4048DUL	40A	80A	120A
M5048DUL	50A	80A	130A
M6048DUL	60A	80A	140A
M8048DUL	70A	2*60A=120A	150A
M10048DUL	80A	2*60A=120A	160A
M12048DUL	100A	2*60A=120A	180A

Note: The M12048DUL is built with two separate 60A MPPT controllers, each one capable of handling different voltages and amperages from different PV arrays.

Its max charging current is not the sum of AC charge current and MPPT charger.

The MPPT solar charger will automatically work when the inverter is powered off.

Even when the power switch is in the off position, the built-in solar charger will automatically work when PV input voltage and battery voltage is in the acceptable range, this is to optimize solar production for battery charging.

With the power switch is in the off position, the inverter will not convert battery power to AC output.

NOTE:

When the battery is fully charged, the MPPT charger will stop working. The battery voltage has to be discharged by 2 volts (or below 98% of SOC when BMS communication is established) to activate the MPPT charger.

Warning:

Don't use the inverters with any types of lithium batteries without BMS.

The inverters charging voltage fluctuates, it will be higher than the CV and float settings.

The protection of lithium batteries must depend on the BMS, not inverters.

2.4.3 DC&AC Transfer

In the Standby Mode, the AC input of the inverter is continuously being monitored. Whenever AC power falls out of the programmed trip voltages, the inverter will automatically transfer back to Invert Mode with minimum interruption to your appliances.

The Inverter / Standby mode transfer delay is between 6 milliseconds and 10 milliseconds.

Though this inverter is not designed as a computer UPS system, the transfer time is fast enough to keep most computers operational, devices like computers can generally tolerate a max power loss for 20ms.

2.4.4 Power Saver

There are two working statuses for M Series inverters: "Power On" and "Power Off".

When power switch is in the "Unit Off" position, the inverter is powered off.

When power switch is turned to either "Power Saver Auto" or "Power Saver Off", the inverter is powered on.

The "Power Saver" function is dedicated to conserve battery power when AC power demand is either minimal or not required at all by the loads.

In this mode, the inverter pulses the AC output looking for an AC load (i.e., electrical appliance). Whenever an AC load (greater than 500 watts at 120Vac) is turned on, the inverter recognizes the need for power and automatically starts inverting and output goes to full voltage. When there is no load (or less than 500 watts) detected, the inverter automatically goes back into search mode to minimize energy consumption from the battery bank.

In "Power saver on" mode, the inverter will draw power mainly in sensing moments, thus the idle consumption is significantly reduced.

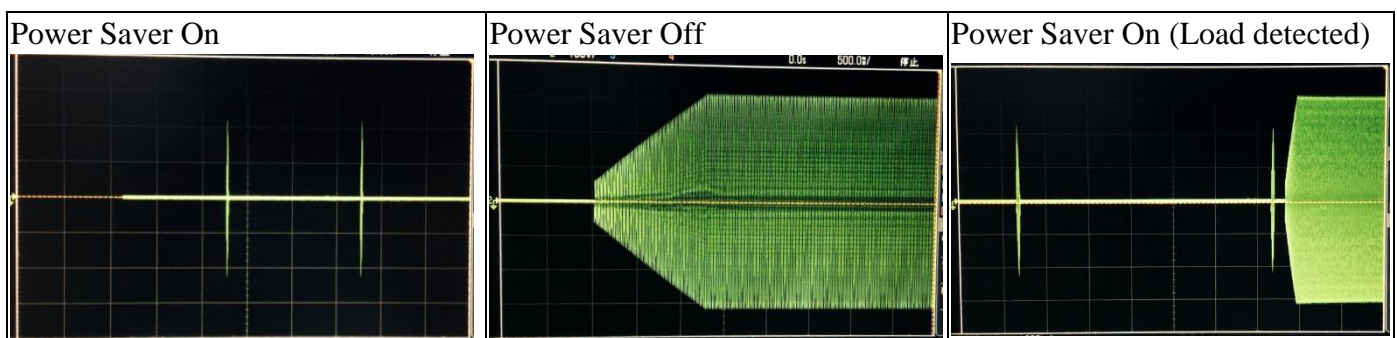

Note: The minimum power of a load to take inverter out of sleep mode (Power Saver On) is 500 Watts on each hot line. There is load detection on each of the hot lines.

When the inverter is in idle, even there is AC input power, the inverter will discharge the battery as the LCD, relay, fans are powered by DC.

M Series Inverter/Charger Idle Power Consumption (in Watts)

Model	Idle(Max)	3Secs(Max)
M4048DUL	80W	20W
M5048DUL	90W	22W
M6048DUL	100W	25.0W
M8048DUL	105W	33W
M10048DUL	110W	35W
M12048DUL	120W	40.0W

For more detailed technical information, please contact us.

In the “search sense” mode, the LED will blink and the inverter will make a ticking sound. At full output voltage, the inverter will make a steady humming sound. When the inverter is used as an “uninterruptible” power supply the search sense mode function should be defeated.

Exceptions

Some devices, when scanned by the load sensor, cannot be detected. Small fluorescent lights are the most common example. (Try altering the plug polarity by turning the plug over.) Some computers and sophisticated electronics have power supplies that do not present a load until line voltage is available. When this occurs, each unit waits for the other to begin. To drive these loads, either a small companion load must be used to bring the inverter out of its search mode, or the inverter may be programmed to remain operating at full output voltage.

2.4.5 Protections

The M Series inverter/charger is equipped with extensive protections against various harsh situations/faults. These protections include:

- **AC Input over voltage protection/AC Input low voltage protection**
- **Low battery alarm/High battery alarm**
- **Over temperature protection/Overload protection**
- **Short Circuit protection (fault after 1s)**

When over temperature /overload occurs, after the fault is cleared, the master switch has to be reset to restart the inverter. The inverter will go to over temp protection when the heat sink temp is over 90°C(194°F) and will go to Fault (shutdown output) after 30 seconds. After temp drops to 45°C(113°F), the switch has to be reset to activate the inverter.

Whenever it triggers protection mode and the fault is cleared, the inverter must be reset to resume work.

2.4.6 Remote Monitoring

The M series inverter can be remotely monitored and controlled.

It supports 4 types of remote monitoring:

1. Plug in the remote LCD panel to the RS485 port. (Applied to ones produced after May 2021).
2. Connect to a computer via the USB port and monitor the inverter on the software.
3. Plug a Wi-Fi or GPRS module into Wi-Fi port, and monitor it on a computer or cellphone APP.
4. Connect to the RS485 port, it allows users to monitor on their own software programmed with the same protocol.

To monitor the inverter on a computer, please download the software (**SG Solar Power Monitor**) from Sigineer Power website in the Support>Software Download section.

<https://www.sigineer.com/support/software-download/>



If an extra LCD switch panel is connected to the inverter via “RS485” port, together with the power switch on the inverter top cover, the two panels will be connected and operated in parallel.

Whichever first switches from “Off” to “On”, it will power the inverter on.

Only when both panels are turned to “Unit Off” position, will the inverter be powered off.

In order for the remote LCD panel to take full control, the inverter box power switch must be in “Off” position.

- The suggested length between the LCD switch panel and inverter is 20 meters.
- The LCD panel allows users to customize the inverter spec on it.



Warning:

Our cables are designed with special pinouts on the connectors, so don't use other cables, or the remote LCD panel will not be powered on.

Never cut the communication cable when it is attached to inverter with battery connected. Doing this, even when the inverter is powered off, it will damage the remote PCB inside if the cable is short circuited during cutting.

The M series inverters can be remotely monitored by a Wi-Fi or GPRS module plugged into its USB port.

The Wi-Fi / GPRS module is a plug-and-play monitoring device which allows users to monitor the status of the PV system from a mobile phone APP or from the website anytime anywhere.

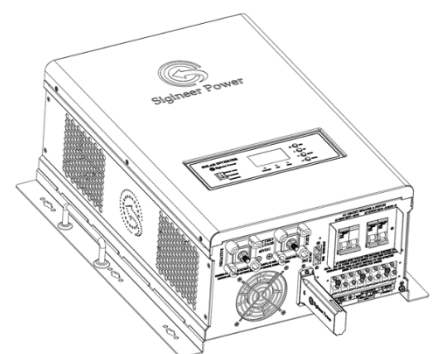

The inverter's AC output power can be powered on and off via the APP.

The **SG Solar Power Monitor** APP will automatically refresh the data in every 5 minutes. To access real date, please roll down the screen to refresh.

To monitor the inverter via both WIFI and USB port, the CUBEWiFi module can be connected via a short extension cable.

2.4.7 LCD & Specification Setup

Press the On/Off switch to turn on the unit.

The operation and display panel area includes three LED function keys and a LCD display.

It shows very rich operating info.



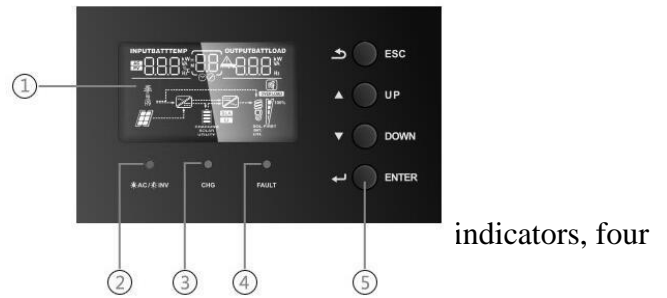



1 LCD display / 2 Status indicator / 3 Charging indicator / 4 Fault indicator / 5 Function buttons















LED Indicator		Operation Status	
☀️ AC / 🏠 INV	Green	Solid On	Output is powered by utility in AC mode.
		Flashing	Output is powered by battery or PV in battery mode.
☀️ CHG	Green	Solid On	Battery is fully charged.
		Flashing	Battery is being charged.
⚠️ FAULT	Red	Solid On	Fault occurs.
		Flashing	Warning condition occurs.



Button	Description
ESC	Exit setting mode
UP	Go to previous selection
DOWN	Go to next selection
ENTER	Enter setting mode or confirm the selection in setting mode.

Icon	Function Description
Input Information	
AC	Indicates the AC input.
PV	Indicates the PV input
INPUTBATT 888 kW VA %C HZ	Indicate input AC voltage, input frequency, PV voltage, battery voltage and charger current.
Configuration Program and Fault Information	

	Indicates the setting programs.
	Indicates the warning and fault conditions.
	Warning Code: Flashing.
	Error Code: Constantly On.
Output Information	
OUTPUTBATTLOAD 	Indicate output voltage, output frequency, load percent, load in VA, load in Watt and discharging current.
Battery Information	
	Indicates battery level by 0-24%, 25-49%, 50-74% and 75-100% in battery mode and charging status in line mode.
SOLAR UTILITY	These two symbols indicate the charge priority. SOLAR indicates solar first. UTILITY indicates utility priority. SOLAR blinking indicates solar only; SOLAR and UTILITY both on indicates combined charging.

CC&CV Charge Mode	Battery Voltage @ Load >50%	Battery Voltage @50%> Load > 20%	Battery Voltage @ Load < 20%	LCD Display
<48V	< 41.2V	< 43.6V	<44.8V	
48-50V	41.2-43.2V	43.6-45.6V	44.8-46.8V	
50-52V	43.2-45.2V	45.6-47.6V	46.8-48.8V	
>52V	> 45.2V	> 47.6V	>48.8V	

Load Information				
OVER LOAD	Indicates overload.			
 	Indicates the load level by 0-24%, 25-49%, 50-74% and 75-100%.			
	0%~24%	25%~49%	50%~74%	75%~100%
				
Mode Operation Information				
	Indicates AC input is available.			
	Indicates PV Input is available.			
BYPASS	Indicates load is supplied by AC power.			
	Indicates the AC to DC charging.			

	Indicates the DC to AC conversion.
SOL.FIRST BAT.FIRST UTI.FIRST	These three signs indicate the AC output priority. SOL.FIRST indicates solar Priority. BAT.FIRST indicates battery priority. UTI.FIRST indicates utility priority.
Mute Operation	
	Indicates unit audible alarm is disabled.

LCD SETTING

The M series inverter LCD allows users to virtually change all of its specs. It will enter setting mode if the ENTER button is held for over 3 seconds. Press “UP” or “DOWN” button to select setting programs, and then press the “ENTER” button to confirm the selection or the ESC button to exit.

Program 01: Power Priority for AC Loads

01 UTI: Utility Priority (Default)

In this mode, the utility will provide power to the AC loads as the first power source. Solar and battery energy will provide power to the loads only when utility power is not available. This mode works for applications with cheap utility power or using battery in power outages.

01 SOL: Solar Priority

In this mode, the solar energy provides power to the loads as the first power source. If solar energy is insufficient, battery energy will be consumed. Utility power will engage when one of below conditions happens:

- 1 Solar energy is not available (No PV production).
- 2 Battery voltage drops to either low-level warning voltage or the setting point in program 12 (DC to AC Transfer Voltage in “SOL Priority”).

Once the solar power is lost, the utility will have higher priority than battery. This mode can be regarded as “SUB”(Solar>Utility>Battery).

In this mode, the inverter will transfer between DC and AC as per the settings of program 12 and 13. Users can set it to utility priority to stop the cycling.

01 SbU: SBU Priority

As indicated by the abbreviation, the power priority comes as solar>battery>utility. Solar energy provides power as first priority. If solar energy is insufficient, battery energy will be consumed. Utility provides power to the loads only when battery voltage drops to either low-level warning voltage or the setting point in program 12(DC to AC Transfer Voltage in “SBU Priority”).

When solar is gone in SBU mode, the power priority becomes battery>utility, battery priority is higher than utility priority.

In this mode, the inverter will transfer between DC and AC as per the settings of program 12 and 13. Users can set it to utility priority to stop the cycling.

Note: When the inverter power priority mode is changed between the three different modes, the setting of other programs will be saved with the associated power priority mode.

Program 02: Maximum Charging Current

6KW model: default 80A, 10A~140A Settable

12KW model: default 80A, 10A~180A Settable

(Note: the max charging current is not the simple sum up of utility charging current + solar charging current for M12048DUL)

The MPPT charger will stop when charging is completed. To activate the charger, the battery voltage must drop at least 2 voltages below the lower value in program 19 and 20.

Program 03: AC Input Voltage Range

The AC Input voltage range in program 03 means the acceptable AC input voltage for load bypassing, it is wider than the “utility charger voltage”

There are two selectable AC input bypass ranges, Appliance Mode and UPS Mode.

The Appliance Mode will give the appliance the maximum amount of power by accepting a wider range of voltage than UPS Mode.

	AC Input Bypass Voltage	Utility Charger Voltage	AC Input Frequency
Appliance Mode	154~272Vac±5V	154V-260Vac	45-65Hz
	164~262Vac±5V(Recover)	164V-250Vac(Recovery)	47-63Hz(Recovery)
UPS Mode	184~272Vac±5V	184V-260Vac	45-65Hz
	194~262Vac±5V(Recover)	194-250Vac(Recovery)	47-63Hz(Recovery)

Program 05: Battery Type

05: AGN

AGM Battery (Default): CV :56.4V, Float 54V

05: FLd

Flood Battery: CV :58.4V, Float 56V

05: USE

User-Defined

If “User-Defined” is selected, battery charge voltage and low DC cut-off voltage can be set up in program 19, 20 and 21. This setting works for GEL batteries etc.

05: US2

User-Defined 2

This US2 setting is designed for the inverter to work with lithium battery without communication via BMS. As floating charging is not required for lithium batteries, in US2 mode, the program 19&20 will be interlocked and set to the same value whenever one of them is changed.

Compared with USE, the charger in US2 will immediately reduce charging current when the preset voltage in 19 is reached.

NOTE: The US2 will not optimally charge the lithium battery due to the lack of BMS communication. The battery capacity icon bar doesn’t reflect the actual battery capacity; it is converted from battery voltage. For more details, please refer to page 13.

When the inverter is in US2, it could not correctly display the accurate SOC of the lithium batteries.

The displayed SOC is converted from battery voltage. The SOC will change only when the battery voltage changes are big enough.

Due to the ripple current from the utility charger, when “US2” is set for charging lithium batteries, it is recommended to set the max utility charging current at 30% of the nominal charge current.

05: LI

Lithium

This setting only works when inverter communicates with lithium battery BMS built with the same protocol. The program is set to “LI”, the LCD will show a hidden program of 36 about BMS protocol types.

There are many lithium battery BMS communication protocols, L01, L02 to L99.

For Sigineer Power LFP power walls, the protocol is L01.

When the battery type set as “LI”, the maximum charge current can be modified by the user.

Note: When the communication fails, the inverter will cut off output.

RS485 communication protocol is L01 to L50.

The CAN communication protocol is L51 to L99.

Program 06: Automatic Overload Restart

06: LfD

Disabled.

06: LFE

When this feature is enabled, the M6KW/M12KW inverter will attempt restart 3 times, if it still fails to start the load, it will shut off.

Program 08: AC Output Voltage

The AC output voltage between two hot lines (or hot and neutral for single phase models) can be set to 208V, 220V, 230V and 240V.

Accordingly, the voltage between each hotline and neutral is 104V, 110V, 115V and 120V.

Program 09: AC Output Frequency

The AC Output Frequency can be set to 50Hz or 60Hz.

Program 11: Maximum Utility Charge Current

Model #	Default Value	Resettable Range
M4048DUL	30A	10-40A
M5048DUL	30A	10-50A
M6048DUL	30A	10-60A
M8048DUL	30A	10-70A
M10048DUL	30A	10-80A
M12048DUL	30A	10-100A

The solar charger has higher priority than the utility charger, if the max charging current and utility charger is set to the same value, the solar charger will still work.

If setting value in Program 02(Total Charge Current) is smaller than that in Program 11(Utility Charge Current), the final charging current is set according to Program 02 for utility charger.

No matter the AC output frequency is set to 50Hz or 60Hz, the acceptable AC input frequency for the utility charger is 45-65Hz.

If the AC input frequency drops out of the 45-65Hz range, the inverter will transfer to battery. The AC input has to return to 47-63Hz to activate the utility charger.

Program 12: DC to AC Transfer Voltage

The setting works when program 01 is in “SBU Priority” or “Solar Priority” Mode.

Model #	Default Value	Resettable Range
4KW- 12KW	46V/40%	44V~56V/5%-50%

The battery SOC will be displayed when BMS communication is established.

Program 13: AC to DC Transfer Voltage

The setting works when program 01 is in “SBU Priority” or “Solar Priority” Mode.

Model #	Default Value	Resettable Range
4KW- 12KW	54V/80%	44V~58V/60%-100%

The battery SOC will be displayed when BMS communication is established.

Program 14: Charger Power Source Priority

14:CSO

Solar Priority

- Solar energy will charge battery as the priority.
- Utility will charge battery only when solar energy is not available (lost).

14:CUT

Utility Priority

- Utility will charge battery as priority.
- Solar energy will charge battery only when utility power is not available (lost).

14:SNU

Solar and Utility (Default)

- Solar energy and utility will both charge battery. But the solar will have higher priority in charging.

14:OSO

Solar Only

- Solar energy will be the only charger source no matter utility is available or not.
- When the battery voltage drops below the setting of 21(Low DC Cut-off Voltage), the utility power will be used to force a charging cycle to avoid battery over discharging.
- If this off grid solar inverter is working in DC to AC invert mode, only solar energy can charge the battery. Solar energy will charge battery if it's available and sufficient.

Program 15: Alarm On/Off Control

Program 16: Backlight On/Off Control

When off is set, the LCD will go dim after 60 seconds left unattended.

Program 17: Beeps once between AC and DC Transfer

Program 19: C.V. Charging Voltage

48V model: default 56.4V, 48.0V~58.4V Settable

- If user-defined setting (USE/US2) is selected in program 5, this program can be set up

Program 20: Float Charging Voltage

48V model: default 54.0V, 48.0V~58.4V Settable

- If user-defined setting (USE/US2) is selected in program 5, this program can be set up

Program 21: Low Battery Cut-Off Voltage

48V model: default 42.0V/20%, 36.0V~52.0V/5%-50% Settable.

- The battery SOC will be displayed when BMS communication is established.
- If user-defined setting (USE/US2) is selected in program 5, this program can be set up
- After User-defined (USE/US2) setting is selected in program 5, this program can be set up
- Low DC cut-off voltage will be fixed to setting value regardless of load percentage.

When low DC Cut-Off voltage is reached:

- If battery is the only power source, inverter will shut down.
- If PV energy and battery power are available, inverter will charge battery without AC output.
- If PV energy, battery power and utility are all available, inverter will transfer to line mode and provide output power to loads and charge the battery at the same time.

When low battery voltage protection occurs and qualified PV or AC power inputs, the inverter will automatically charge and invert DC to AC when the battery voltage is 2Vdc higher than low battery cut off (Or 10% more SOC than low battery cut off in Lithium mode).

To make it work, the power switch must remain in the original “ON” position.

The minimal voltage for the LCD to illuminate is 30Vdc for 48V models.

For the M6048DUL and M12048DUL inverter, the High DC Cut-Off Voltage varies for different type of batteries.

It is 60V for AGM battery, 62V for flood battery, 4 volts higher than the CV voltage in USE or Li Mode. The inverter will go to high voltage alarm when the battery voltage is reached and go to Fault after 60 seconds.

Note: When the Program 12: DC to AC Transfer Voltage value is set, the Program 21: Low Battery Cut-Off Voltage value must be lower than that.

Program 22: RS485 Communication Address

Default 001. 001-255. Settable. It is for external solar charger expansion.

Program 23: Battery Equalization

If “Flooded” or “User-Defined” is selected in program 05, this program can be set up. The Equalization is not available for AGM batteries.

Program 24: Battery Equalization Voltage

Model #	Default Value	Resettable Range
4KW- 12KW	58.4V	48-58.4V

Program 25: Battery Equalized Time

Default 60min, 5min~900min Settable

Program 26: Battery Equalized Timeout

Default 120min, 5min~900min Settable

Program 27: Equalization Interval

Default 30days, 1 day~90 days Settable

Program 28: Equalization Activated Immediately

If equalization function is enabled in program 23, this program can be set up. If “Enable” is selected in this program, it will activate battery equalization immediately and LCD main page will shows “Eq”. If “Disable” is selected, it will cancel equalization function until next activated equalization time arrives based on program 27 setting. At this time, “Eq” will not be shown in LCD main page.

Note:

Some of the program settings are interlocked with other settings, for example:

- 1 When the program 05 is set to AGM、FLD、LI, the program 19, 20 and 21 will be locked to factory default value.
- 2 When program 05 is set to LI, the program 02 max charging current will be locked.
- 3 Program 12 value must be smaller than program13.
- 4 Program 21 value must be smaller than program 12.
- 5 Program 11 value must be smaller than program 02.

Program #	Description	ICON
01 Power Priority for AC Loads	Utility Priority	01 UTI
01 Power Priority for AC Loads	Solar Priority	01 SOL
01 Power Priority for AC Loads	SBU Priority	01 SBU
02 Maximum Charging Current	Max PV+ Utility Charging Current	02 80 ^A
03 AC Input Voltage Range	Appliance Mode (default)	03 APL
03 AC Input Voltage Range	UPS Mode	03 UPS
05 Battery Type	AGM Battery (Default)	05 AGM
05 Battery Type	Flood Battery	05 FLd
05 Battery Type	User-Defined	05 USE
05 Battery Type	User-Defined 2	05 US2
05 Battery Type	Lithium	05 LI

06 Automatic Overload Restart	Restart Disable (default)	06 Lfd
06 Automatic Overload Restart	Restart Enable	06 LfE
08 AC Output Voltage	240V (default)	08 240 ^v
09 AC Output Frequency	50Hz (default)	09 50 ^{Hz}
11 Maximum Utility Charging Current	10A to Max(default 30A)	11 30 ^A
12 DC to AC Transfer Voltage	Default 46.0V, 44.0V~51.2V settable	12 46.0 ^v
12 DC to AC Transfer Voltage	Lithium mode: default 40%, 5%~50% settable	12 40 [%]
13 AC to DC Transfer Voltage	Default 54.0V, 48.0V~58.0V Settable	13 54.0 ^v
13 AC to DC Transfer Voltage	Li mode: default 80%, 60%~100% settable	13 80 [%]
14 Charger Power Source Priority	Solar Priority	14 C50
14 Charger Power Source Priority	Utility Priority	14 CUE
14 Charger Power Source Priority	Solar and Utility (Default)	14 SNU
14 Charger Power Source Priority	Solar Only	14 O50
15 Alarm On/Off Control	Audible Alarm on (default)	15 60n
15 Alarm On/Off Control	Audible Alarm off (Mute)	15 60F
16 Backlight On/Off Control	Backlight on (default)	16 L0n

16 Backlight On/Off Control	Backlight off When off is set, the LCD will go dim after 60 seconds left unattended.	16 L0F
17 Beeps once between AC and DC Transfer	Alarm on (default)	17 A0N
17 Beeps once between AC and DC Transfer	Alarm off	17 A0F
19 C.V. Charging Voltage	48V model: default 56.4V, 48.0V~58.4V Settable	CV 19 56.4 ^v
20 Float Charging Voltage		FLV 20 54.0 ^v
21 Low Battery Cut-Off Voltage	Without BMS communication	COV 21 42.0 ^v
21 Low Battery Cut-Off Voltage	With BMS communication	COV 21 20
22 RS485 Communication Address	Default 001. 001-255 Settable. For external solar charger expansion.	Adt 22 001 (default)
23 Battery Equalization	Disabled (Default)	E9 23 di S (default)
23 Battery Equalization	Enable	E9 23 ENA
24 Battery Equalization Voltage	Default 58.4V, 48~60V settable	E9V 24 58.4 ^v (default)
25 Battery Equalization Time	Setting range is from 5min to 900min. Increment of each click is 1min.	Edt 25 060 (default)
26 Battery Equalization Timeout	Setting range is from 5min to 900min. Increment of each click is 1 min.	EtO 26 120 (default)
27 Equalization Interval	Setting range is from 1 to 30 days. Increment of each click is 1 day.	EIt 27 001 (default)
28 Equalization Activated Immediately	Disabled (Default)	AtV 28 di S (default)

28 Equalization Activated Immediately	Enable	ATV 28 ENA
--	--------	------------

Display Setting

The LCD display information can be changed by pressing the “UP” or “DOWN” key. The selectable information is displayed in the following order: input voltage, input frequency, PV voltage, MPPT charging current, MPPT charging power, battery voltage, output voltage, output frequency, load percentage, load in VA, load in Watt, DC discharging current, inverter PCB software version and MPPT PCB software version.

<p>INPUT AC 230^v</p> <p>OUTPUT 230^v</p> <p>Input voltage/Output voltage (Default home screen)</p>	<p>INPUT AC 500^{Hz}</p> <p>OUTPUT 230^v</p> <p>Input frequency</p>	<p>BATT 30^A</p> <p>OUTPUT 230^v</p> <p>AC charging current</p>
<p>INPUT PV 110^v</p> <p>OUTPUT 230^v</p> <p>PV voltage</p>	<p>BATT 80^A</p> <p>OUTPUT 230^v</p> <p>PV charging current</p>	<p>BATT 500^w</p> <p>OUTPUT 230^v</p> <p>PV Charging power</p>
<p>BATT AC PV 80^A</p> <p>OUTPUT 230^v</p> <p>Total Charging current(PV + Utility)</p>	<p>BATT 52.1^v</p> <p>BATT 500^{Hz}</p> <p>Output frequency</p>	<p>BATT 510^v</p> <p>LOAD 500[%]</p> <p>Load percentage</p>
<p>BATT 510^v</p> <p>LOAD 270^w</p> <p>Load in Watt</p>	<p>Load < 1kVA, displayed in xxx VA .</p> <p>INPUT 230^v</p> <p>LOAD 350^{VA}</p> <p>Load in VA</p>	
<p>Load ≥ 1KVA, displayed in x.x kVA.</p> <p>INPUT 230^v</p> <p>LOAD 350^{VA}</p> <p>Load in VA</p>		<p>INPUT 230^v</p> <p>LOAD 350^{VA}</p> <p>Load in VA</p>

<p>BATT 510 LOAD 3.50 kw</p> <p>CHARGING SOLAR UTILITY SLA UTL.FIRST</p> <p>Load in Watt ($\geq 1KW$)</p>	<p>BATT 52.1v BATT 58 A</p> <p>SOLAR UTILITY SLA UTL.FIRST</p> <p>DC discharging current</p>	<p>6.00 kW</p> <p>SOLAR SLA</p> <p>Inverter Rated Power</p>
<p>BATT 510 BATT 50%</p> <p>CHARGING SOLAR UTILITY SLA</p> <p>Battery Level</p>	<p>BATT 58.2v OUTPUT 225v</p> <p>CHARGING SOLAR UTILITY SLA</p> <p>Battery Equalization</p>	
<p>028 00 306</p> <p>CHARGING SOLAR SLA UTL.FIRST</p> <p>Inverter PCB Software Version 028-00-306</p>	<p>029 00 319</p> <p>CHARGING SOLAR SLA UTL.FIRST</p> <p>MPPT PCB Software Version 029-00-319</p>	

The LCD will display different inverter status when the up or down button is pressed.

The last two pages of LCD show the software version of the inverter PCB and MPPT PCB. There are 8 digits.

If the MPPT PCB is not activated, it will display 000-00-000.

When the LCD is switched to a new page, the LCD will return to the default home screen in 2 minutes without operation.

When the LCD enters the setting page, the LCD will return to the default home screen in 10 minutes without operation.

Operating Mode Description

Operation Mode	Description	LCD Display
<p>Standby mode</p> <p>Note:</p> <p>*Standby mode: Inverter power off, solar charger activated, utility charger disabled.</p>	<p>In standby mode, the PV power only charges batteries, the inverter will not invert DC to AC.</p>	<p>Utility charger is disabled, only PV can charge batteries.</p> <p>CHARGING SOLAR UTILITY SLA</p>
<p>Line Mode</p>	<p>Utility power is designated to power loads and solar is designated to charge batteries.</p>	<p>Charging by PV energy</p>

	The unit will provide AC output power from the utility. It will also charge the battery in line mode.	<p>Charging by utility</p>
Battery Mode	The unit will provide AC output power from battery and PV power.	<p>Power from battery and PV energy.</p>
		<p>Power from battery only.</p>

The inverter is built with automatic PV and utility power wakeup feature.

- When the power switch is in power off, and qualified PV input, the PV charger will be activated, and the rest part of the inverter will remain powered off. In this mode, the utility power can only illuminate the LCD, it can't charge batteries.
- When the inverter shuts off due to low battery voltage, and the switch is kept on "on" position, the inverter will use qualified utility power or PV power to charge batteries and wake up at "cold start voltage" to discharge the battery to provide AC output.
- If the inverter is set in SOL or SUB, the automatic wake up feature will charge battery close to "Utility to Battery switch" voltage, and then cut off utility charger, switch to DC to AC model.

2.4.8 Audible Alarm

The inverter also gives audible alarms when the following situations occur.

Warning	Buzzer beeps 0.5s every second.
Error	Long Beep. Beeps 0.5s every 1s for 10s, shut off, then long beep for 60 seconds.

2.4.9 FAN Operation

For M Series 4-6KW models, there are one DC fan and one AC fan.

For M Series 8-12KW models, there are two DC fans and one AC fan.

The DC & AC fans will work together, they are designed to operate according to the following logic:

Condition	Enter Condition	Leave Condition	Fan Operation
HEAT SINK TEMPERATURE	$T \leq 40^{\circ}\text{C}(104^{\circ}\text{F})$	$T > 40^{\circ}\text{C}(104^{\circ}\text{F})$	OFF
	$T > 40^{\circ}\text{C}(104^{\circ}\text{F})$	$T \leq 40^{\circ}\text{C}(104^{\circ}\text{F})$	ON

UTILITY CHARGER CURRENT	$I \leq 20A$	$I > 20A$	OFF
	$I > 20A$	$I \leq 20A$	ON
LOAD PERCENTAGE (INV MODE)	$20\% \leq \text{Load}$	$\text{Load} > 20\%$	OFF
	$\text{Load} > 20\%$	$20\% \leq \text{Load}$	ON

Allow at least 80CM of clearance around the inverter for air flow. Make sure that the air can circulate freely around the unit.

The max fan noise level is 72db at a distance of 1m.

2.4.10 Automatic Generator Start

The 4KW-12KW solar inverters are built with a very versatile 3-pin dry contact rated at 3A/250VAC on the rear panel.

The internal relays of the dry contact will give out either “close” or “open” signals.

These signals can be used to indicate the low battery voltage alarm or control a generator.



The NC & C pins are constantly close, they will open when battery voltage reaches low alarm.

The NO & C pins are constantly open, they will close when battery voltage reaches low alarm to start the generator. Once the generator is started and battery voltage increases with charging, the dry contact pins will only open when the setting of Program 19 (CV Charging Voltage) is reached to avoid overcharging. The NO & C pins will close again when battery voltage reaches low alarm.

Unit Status	Operation	Battery Voltage	NC & C	NO & C
Power Off	Inverter off (No AC output)		Close	Open
Power On	Inverter in AC Bypass Mode		Close	Open
		> Low Battery Alarm	Close	Open
	Inverter in DC to AC Mode	<= Low Battery Alarm	Open	Close
		> Program 19 (CV Charging Voltage)	Close	Open
		> Low Battery Alarm	Close	Open
		<= Low Battery Alarm	Open	Close
> Program 19 (CV Charging Voltage)	Close	Open		

For low battery alarm, when battery setting is not in “LI” mode, it is 2 volts higher than Program 21 Low DC Cut-off Voltage for 48Vdc model.

When the battery setting is in “LI” mode, low battery alarm is 5% higher than Low DC Cut-off Soc.

Note: This diagram only works for certain types of generators. For your specific generator wiring, pls contact the generator supplier or us for wiring.

2.4.11 Automatic Recovery Operation

For the 4KW- 12KW inverters, it is designed with automatic recovery from:

- Overloads
- Low battery voltage cutoff.

Please refer to “Program 06 Automatic Overload Restart” and “Program 21 Low Battery Cut-Off Voltage” for more details.

2.4.12 Other Features

Conformal Coating

The entire line of M series inverters has been processed with a conformal coating on the PCB, making it water, rust, and dust resistant.

While these units are designed to withstand corrosion from the salty air, they are not waterproof.

3 Installation

3.1 Location

Follow all the local regulations to install the inverter.

Please install the equipment in a location of Dry, Clean, Cool with good ventilation.

Working temperature: 0°C to 50°C (32°F to 122°F)

Storage temperature: -20°C to 60°C (-4°F to 144°F)

Relative Humidity: 0% to 95%, non-condensing

Cooling: Forced air

Warning! Operation in an environment where water vapor condenses on the unit will invalid warranty.

3.2 Unpacking and Inspection

Before installation, please inspect the unit. Be sure that nothing inside the package is damaged. You should have received the following items in the package:

- Inverter x 1
- User manual x 1
- Communication cable x 1 set
- Wi-Fi Module x 1 (Optional for M6048DUL and M12048DUL)

Mounting the Unit

Consider the following before selecting where to install:

- Do not mount the inverter to flammable construction materials. Mount to a solid surface.
- Install inverter at eye level in order to allow the LCD display to be read at all times.
- Refer to the environmental temperature recommendations above for optimal operation.
- Vertical orientation is recommended. Don't install the inverter upside down, overheating will occur.
- Adhere to the clearance recommendations in the diagram to allow for heat dissipation and connecting / disconnecting wiring.
- **SUITABLE FOR MOUNTING ON CONCRETE OR OTHER NON-COMBUSTIBLE SURFACE.** If it is mounted to a wood or metal surface, please take precaution on the electrical safety and fire prevention.
- Use screws, bolts, or other mounting hardware of sufficient strength and length to secure the unit to the mounting surface.

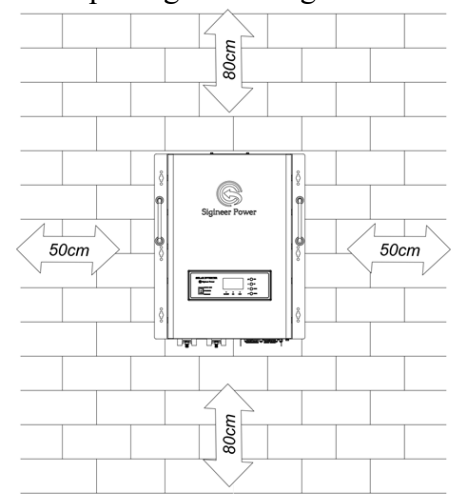

3.3 Battery Wiring

Before connecting the batteries, please take off the DC and AC terminal covers by removing their screws.

DC terminal bolt size: M8.

Keep the battery bank as close as possible to the inverter.

Follow the suggested cable length in the table below.

Model Watt	Battery Voltage	Minimum Wire Gauge		Model Watt	Battery Voltage	Minimum Wire Gauge	
		0~1.0m	1.0~5.0m			0~1.0m	1.0~5.0m
12KW	48 Vdc	90mm ²	120mm ²	6KW	48 Vdc	45mm ²	60mm ²
10KW	48 Vdc	75mm ²	90 mm ²	5KW	48 Vdc	40 mm ²	50 mm ²
8KW	48 Vdc	60mm ²	75 mm ²	4KW	48 Vdc	30 mm ²	40 mm ²

Please follow the above minimum wire size requirement.

One cable from the battery to the inverter is always best. If you can't use one cable of sufficient length, you may use two cables so long as the square area of both cables adds up to the recommended square of the minimum wire gauge. For example, one cable of 100mm² can be replaced by two cables of 50mm² to obtain the recommended wire gauge. When in doubt, round up and keep the cable length as short as possible.

Battery cables must have crimped (or preferably, soldered and crimped) copper compression lugs unless aluminum mechanical lugs are used. Soldered connections alone are not acceptable. High quality, UL-listed battery cables are available. These cables are color-coded with pressure crimped, sealed ring terminals.

Battery terminals must be clean to reduce the resistance between the DC terminal and cable connection. A buildup of dirt or oxidation may eventually lead to the cable and / or the terminal overheating during periods of high current draw. Use a stiff wire brush to remove all dirt and corrosion from the battery terminals and cables.

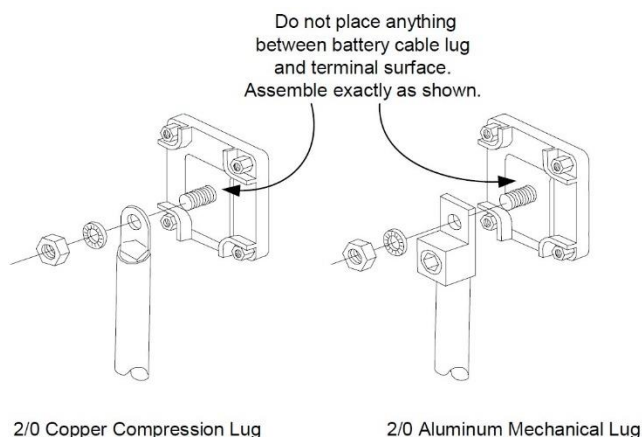

Reducing RF interference

To reduce the effect of radiated interference, twist the DC cables. To further reduce RF interference, shield the cables with sheathing /copper foil / braiding.

Taping battery cables together to reduce inductance

Do not keep the battery cables far apart. In case it is not convenient to twist the cables, keep them taped together to reduce their inductance. Reduced inductance of the battery cables helps to reduce induced voltages. This reduces ripple in the battery cables and improves performance and efficiency.

CAUTION: For safety operation and regulation compliance, it's required to install a separate DC over-current protector or disconnect device between battery and inverter. It may not be required to have a disconnect device in some applications, however, it's still required to have over-current protection installed. Please refer to typical amperage in the table below for required fuse or breaker size.

Model #	Nominal DC INPUT Current	Recommended fuse or breaker size
---------	--------------------------	----------------------------------

M4048DUL	110A	140A
M5048DUL	140A	160A
M6048DUL	166A	200A
M8048DUL	220A	300A
M10048DUL	276A	350A
M12048DUL	332A	400A

 WARNING	<p>The torque rating range for DC terminal is 12.5NM-20.5NM(9.25-15.19 pound-foot), and the suggested torque rating is 17NM(12.6 pound-foot). Over torquing may cause the bolt to break.</p>
	<p>Equipment Damage The inverter is not reverse polarity protected. Reversing the battery polarity on the DC input connections will cause permanent damage to the inverter which is not covered under warranty. Always check polarity before making connections to the inverter.</p>
	<p>The inverter contains capacitors that may produce a spark when first connected to battery. Do not mount in a confined a battery or gas compartment.</p>
	<p>Ensure the inverter is off before disconnecting the battery cables, and that AC power is disconnected from the inverter input.</p>

3.4 PV Wiring

CAUTION: Before connecting to PV modules, please install a separate DC circuit breaker between inverter and PV modules as per the solar charger rating.

The PV terminal pins diameter is 6mm, they can accept cable size up to 6AWG (Diameter 4.115mm), and the torque for the screws is 1.8Nm.

Max. PV Array Open Circuit Voltage is 250Vdc, please make sure Open Circuit Voltage (Voc) of PV modules does not exceed 250Vd and is higher than 34Vdc.

The PV voltage must be higher than battery voltage to activate charging. There is no voltage boost in the MPPT module.

PV Array MPPT Voltage Range: 60~245Vdc

Minimal Battery Voltage for PV charge: 34Vdc

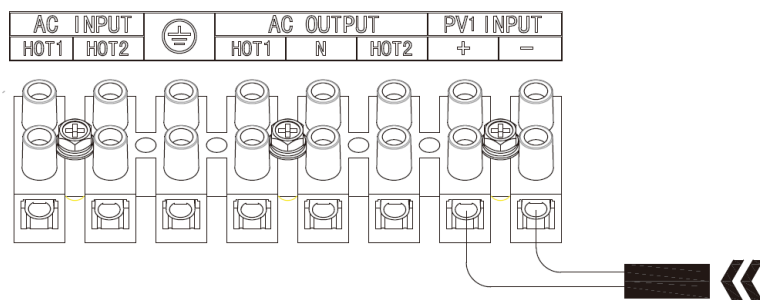

Note: The M8048DUL, M10048DUL, M12048DUL has two separate 60A MPPT solar chargers which can accept PV input with different voltages and amperages.

3.5 AC Wiring

The AC terminal pins diameter is 6mm, they can accept cable size up to 6AWG (Diameter 4.115mm), and the torque for the screws is 1.8Nm.

We recommend using up to **5AWG** wire to connect to the ac terminal block. Use the heavier gauge if you can.

Before connecting to AC input power source, please install a separate AC breaker between inverter and AC

input power source. This will ensure the inverter can be securely disconnected during maintenance and fully protected from over current of the AC input. The recommended specification of the AC breaker is 63A for 4KW~6KW, 80A for 8KW~12KW.

When in AC mode the AC input power will supply both the loads and AC charger, a heavier wire gauge for AC Input is required. Please consult a qualified electrician about the specific wire gauge required.

There are 3 different ways of connecting AC input and output to the terminal block depending on the model. Call our tech support if you are not sure about how to wire any part of your inverter.

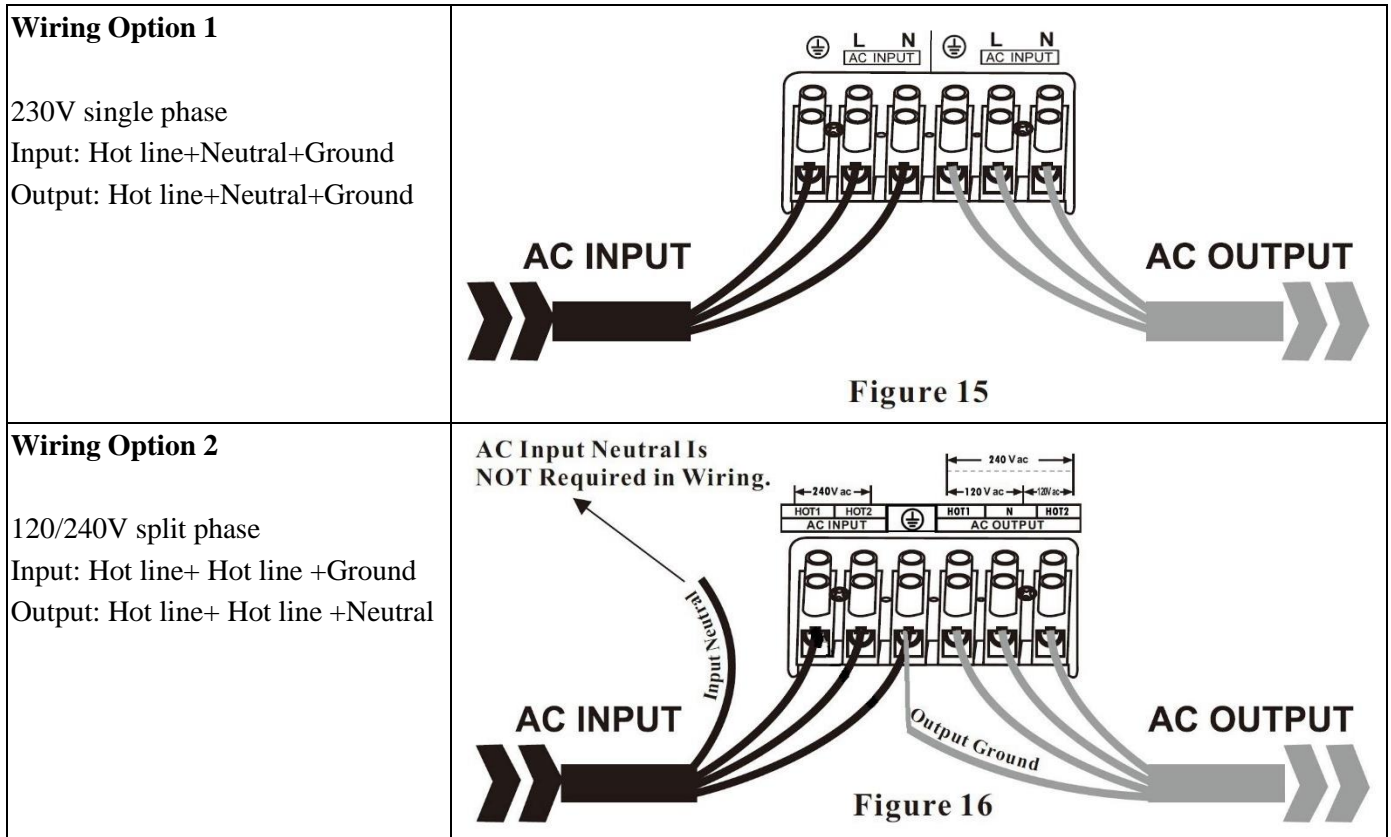

Note:

As the two split phase hot lines is 180 degrees out of phase with each other, the inverter is only able to output full power at 240Vac.

Users can only get 50% nominal power from each one of the 120Vac hot lines of the split phase inverter.

The biggest 120V single load the inverter can drive is 50% of its nominal power.

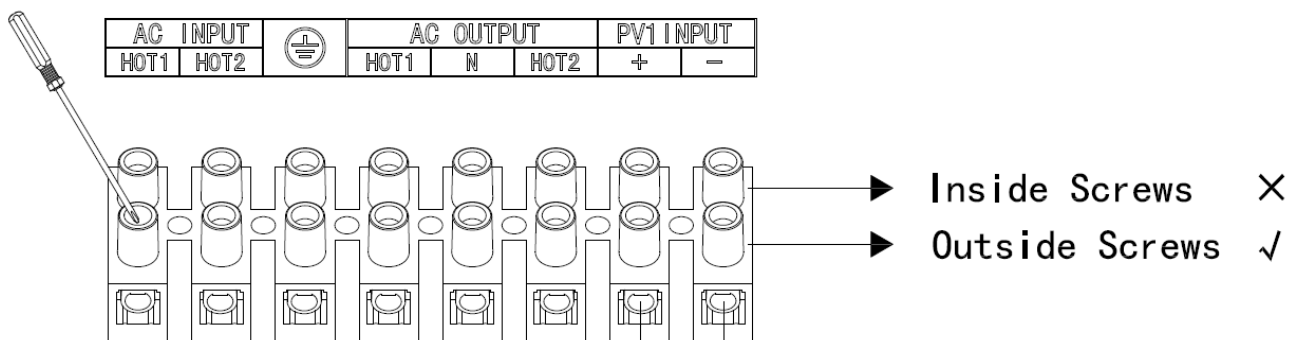

Don't loosen the inside screws holding the internal cables!

Damage caused by loosening inside screws is not covered under warranty!



Caution:

Wiring Option 2 and Wiring Option 3 are only allowed for split phase models.

Please wire the single phase models according to Wiring Option 1.

In case the split phase model is used in 230V single phase systems, please email us at info@sigineer.com for instructions.

 WARNING	<p>For split phase models, AC input neutral is not required in wiring. Never Connect Input Neutral to Ground or to Output Neutral. Damage will result which is not covered under warranty.</p> <p>The output voltage of this unit must never be connected in its input AC terminal, overload or damage may result.</p> <p>Always switch on the inverter before plugging in any appliance.</p> <p>Damages caused by AC wiring mistakes are not covered under warranty.</p>
--------------------	---

CAUTION: Appliances such as air conditioner are required at least 2~3 minutes to restart because it's required to have enough time to balance refrigerant gas inside of circuits. If a power shortage occurs and recovers in a short time, it will cause damage to your connected appliances. To prevent this kind of damage, please check with manufacturer of air conditioner that if it's equipped with time-delay function before installation. Otherwise, this off grid solar inverter will trigger overload fault and cut off output to protect your appliance but sometimes it could still cause damage to the air conditioner.

Preventing Paralleling of the AC Output

The AC output of the unit should never be connected to the utility power / generator.

Such a connection may result in parallel operation of the different power sources and AC power from the utility / generator will be fed back into the unit which will instantly damage the inverter and may also pose a fire and safety hazard.

3.6 Communication With Lithium Batteries

The BMS port allows the M series inverters to communicate with lithium batteries BMS with the same protocol. Our M series inverters support a growing number of lithium batteries from the larger manufacturers.

To get more details of our BMS protocol and the compatible lithium battery models, please email us at info@sigineer.com.

Please follow below steps to implement lithium battery connection:

Connect one end of RJ45 of battery to BMS communication port of inverter. Connect the other end of RJ45 cable to battery communication port.

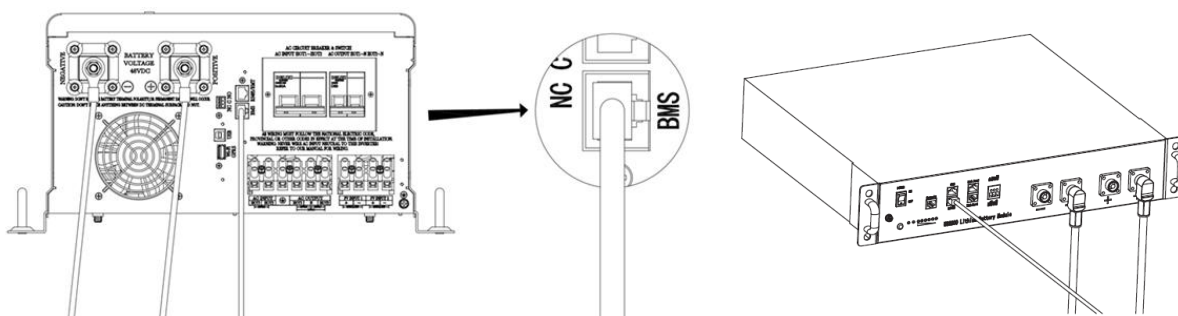

Make sure the lithium battery BMS port connects to the inverter is Pin to Pin, The BMS port supports communication with BMS by RS485 protocol or CAN protocol.

The inverter BMS port pin and RS485 port pin assignment is shown as below.

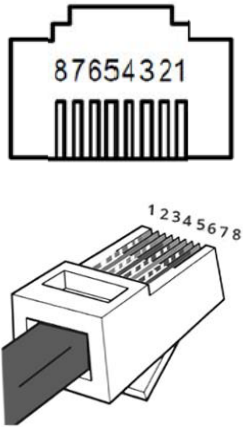
	PCB Type	CAN PROTOCOL	
	Pinout	BMS port	RS485 port
	Pin#1	RS485B	RS485B
	Pin#2	RS485A	RS485A
	Pin#3	--	--
	Pin#4	CANH	--
	Pin#5	CANL	--
	Pin#6	--	--
	Pin#7	--	--
Pin#8	--	--	

Lithium battery setting in LCD

To make the inverter communicate with the battery BMS, the battery type should be set to “LI” in Program 05. Please refer to “05: LI” for details.

Note:

When multiple inverters are paralleled with multiple lithium batteries, please follow the below setup.

- 1 Out of the lithium batteries, set one unit as the master and the rest as slave as per the lithium DIP switches.
- 2 Connect the master unit with the inverter which shows “Host”.

If the user connects the master battery to one of the rest slave inverters in the group, the inverter will automatically work as the master unit, but the communication will be slower.

3.7 Communication With Computer

The inverter can be monitored on the computer.

Please use the communication cable to connect to inverter and PC. Insert bundled CD into a computer and follow on-screen instruction to install the monitoring software. For the detailed software operation, please check user manual of software in the CD.

3.8 Grounding

Connect an AWG 8 gauge or greater copper wire between the grounding terminal on the inverter and the earth grounding system or the vehicle chassis.

3.9 Mounting Flange

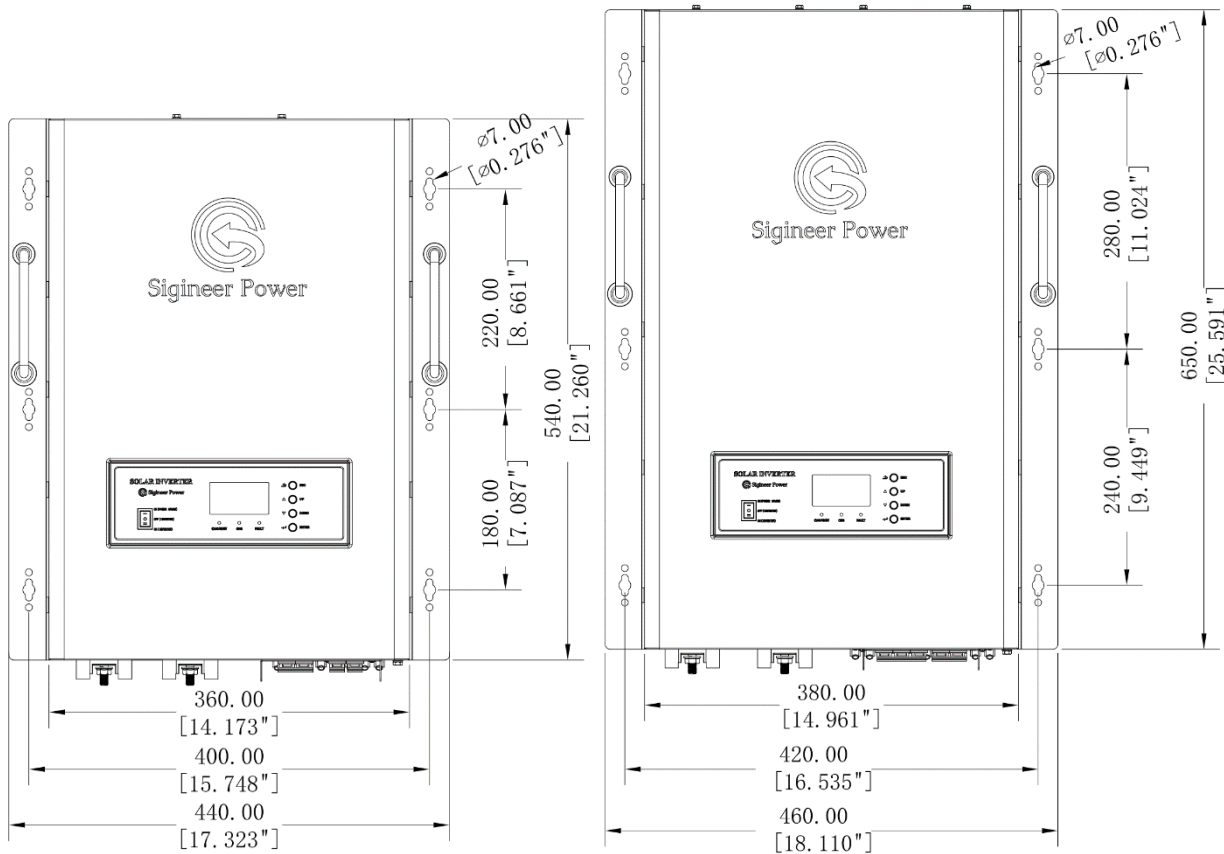
M4048DUL/M5048DUL/M6048DUL
M8048DUL/M10048DUL/M12048DUL

4 Maintenance & Troubleshooting

This troubleshooting guide contains information about how to troubleshoot possible error conditions while using the M Series Pure Sine Wave Inverter/Charger.

The following chart is designed to help you quickly pinpoint the most common inverter failures.



Code, Indicator and Buzzer







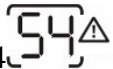

There are two types of alarms: Warning and Fault.

When the warning is triggered, the inverter will still operate until it becomes a “Fault”.

When a fault is triggered, the inverter will shut off and needs to be manually reset to resume operation.

Warning Code	Warning Event	Audible Alarm
01 01 [△]	Inverter Fan Abnormal	Beep once every second
03 03 [△]	High Battery Voltage	Beep once every second
04 04 [△]	Low Battery Voltage	Beep once every second
07 07 [△]	Overload In Inverter Mode	Beep once every second
12 12 [△]	Solar Charger Over Temperature	Beep once every second
51 51 [△]	Solar Charger Over Current	Beep once every second

54 	High PV Voltage Protection	Beep once every second
58 	AC Output Low Voltage(<180V)	Beep once every second
61 	Battery Voltage Detection Discrepancy Error When it is over 0.5V between inverter and MPPT.	Beep once every second

Fault Code	Fault Event	Icon On
02	Inverter Over Temperature	
03	Battery Overvoltage	
04	Battery Undervoltage	
05	AC Output Short Circuit	
06	High AC Output Voltage In Inverter Mode	
07	Overload In Inverter Mode	
20	BMS Communication Loss	
51	Inverter Over Current	

Trouble Shooting

Symptom	LCD/LED/Buzzer	Possible Cause(s)	Recommended Solution(s)
Inverter will not turn on during initial power up.	LCD/LEDs and buzzer will be active for 3 seconds and then complete off.	The battery voltage is too low (<45.8V). Batteries are not connected, loose battery-side connections.	Check the batteries and cable connections. Check DC fuse and breaker. Charge battery. Replace battery.
No response after power on.	No indication.	The battery voltage is far too low. (<33.6V) Battery polarity is connected reversed.	Check if batteries and the wiring are connected well. Re-charge battery. Replace battery.
Buzzer beeps continuously and red LED is on.	Fault code 02	Over Temperature Internal component temperature is over 90°C.	Check if the air flow of the unit is blocked or the ambient temperature is too high.
	Fault code 03	Battery is over-charged.	Return to repair center.
	Fault code 03 Fault code 04	The battery voltage is too high.	Check if the spec and quantity of batteries are

		acceptable.
	The battery voltage is too low.	Check if the spec and quantity of batteries are acceptable.
Fault code 05	AC Output short circuit.	Check if wiring is connected well and remove the abnormal load.
Fault code 06/58	Output abnormal (Inverter AC voltage below 180Vac or over 290Vac)	Remove the connected load. Return to repair center
Fault code 07	Overload error. The inverter is overloaded over 110% and time is up.	Reduce load wattage.
Fault code 20	BMS communication failed.	Check the BMS communication wire to see if it's well connected Check the transceiver signal
Fault code 51	Over Current In Invert Mode	Restart the unit, if the error happens again, please return to repair center.

***The reason for the noise from transformer and/or case**

When in inverter mode and the transformer and/or case of the inverter sometimes may vibrate and make noise.

The noise may come from transformer.

According to the characteristics of our inverter, there is one type of load which is most likely to cause rattles of the transformer; that is a half-wave load, load that uses only a half cycle of the power (see figure 1). This tends to cause an imbalance of the magnetic field of the transformer, reducing its rated working frequency from 20KHz to, say, maybe 15KHz (it varies according to different loads). This way, the frequency of noise falls exactly into the range (200Hz-20KHz) that human ear can hear.

The most common load of such kind is a hair drier.

If the noise comes from the inverter case.

Normally when loaded with inductive loads, the magnetic field generated by transformer keeps attracting or releasing the steel case at a specific frequency, this may also cause noise.

This noise may also be generated the moment a load is detected in the power saver mode.

Reducing the load power or using an inverter with higher capacity will normally solve this problem.

The noise will not do any harm to the inverter or the loads.

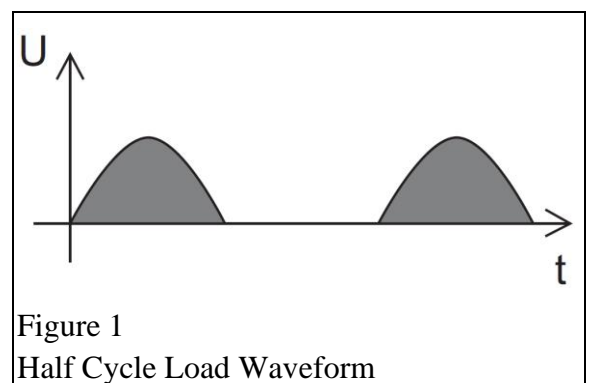

5 Warranty

We warrant this product against defects in materials and workmanship for a period of one year from the date of purchase and will repair or replace any defective M Series Inverter when directly returned, postage prepaid, to manufacturer. This warranty will be considered void if the unit has suffered any obvious physical

damage or alteration either internally or externally and does not cover damage arising from improper use such as plugging the unit into an unsuitable power sources, attempting to operate products with excessive power consumption requirements, reverse polarity, or use in unsuitable climates.

WARRANTY DOES NOT INCLUDE LABOR, TRAVEL CHARGES, OR ANY OTHER COSTS INCURRED FOR REPAIR, REMOVAL, INSTALLATION, SERVICING, DIAGNOSING OR HANDLING OF EITHER DEFECTIVE PARTS OR REPLACEMENT PARTS. THE WARRANTOR ASSUMES NO LIABILITY FOR INCIDENTAL OR CONSEQUENTIAL DAMAGES OF ANY KIND.

LOSS OR DAMAGE: Loss or damage in transit is the responsibility of the carrier. Any claim should be filed with the delivering transport company. Invoice, Bill of Lading and Delivery receipt with damage noted therein must accompany any claims for freight damage. Claims for shortage and lost shipments must be made in writing to the shipper within 3 days of the receipt of shipment. Claims not reported within this time frame will not be honored.

This warranty does not apply to and we will not be responsible for any defect in or damage to:

- a) the product if it has been misused, neglected, improperly installed, physically damaged or altered, either internally or externally, or damaged from improper use or use in an unsuitable environment; violations of the warnings in the manual will invalidate the warranty.
- b) the product if it has been subjected to fire, water, generalized corrosion, biological infestations, or input voltage that creates operating conditions beyond the maximum or minimum limits listed in the product specifications including high input voltage from generators and lightning strikes;
- c) the product if repairs have been done to it other than by us or its authorized service centers;

Appendix 1 : M Series Inverter/Charger Spec Sheet

MODEL	M4048DUL	M5048DUL	M6048DUL	M8048DUL	M10048DUL	M12048DUL
Battery voltage	48VDC	48VDC	48VDC	48VDC	48VDC	48VDC
INVERTER OUTPUT						
Rated Power	4KW	5KW	6KW	8KW	10KW	12KW
Surge Rating (5sec)	8KW	10KW	12KW	16KW	20KW	24KW
Surge Rating (20ms)	12KW	15KW	18KW	24KW	30KW	36KW
Waveform	Pure sine wave/ same as input (bypass mode)					
Nominal Output Voltage	208V-220V-230V-240Vac (+/-10% RMS) Adjustable					
Output Frequency	50Hz/60Hz (+/-0.3 Hz) Adjustable					
Inverter Efficiency(Peak)	>85%					
Line Mode Efficiency	>95%					
Power Factor	1.0					
48V MPPT SOLAR CHARGER						
Maximum PV Charge Current	80A			120A		
Efficiency	Tracking: 99.5%. Charging: 96%.					
Maximum PV Input Power	5000W			7000W		
MPPT Operating Voltage	60-245Vdc					
Max. PV Open Circuit Voltage (Voc)	250VDC					
CV / Float Charge Voltage	48.0V~58.4V Resettable					

PV Charge Initiation Condition	Batter voltage > 30Vdc & PV voltage must be at least 5 volts higher than battery voltage.					
DC INPUT						
Low DC Cut-Off Voltage (For Lead Acid)	36-52V Adjustable					
Low DC Warning Voltage (For Lead Acid)	Low DC Cut-off Voltage +2Vdc					
Low DC Warning Return Voltage (For Lead Acid)	>48V					
Low DC Warning SOC (For Li)	Low DC Cut-off Soc +5%					
Low DC Warning Return SOC (For Li)	Low DC Cut-off Soc +15%					
Low DC Cut-off SOC (For Li)	Default 20%, 5%~50% Adjustable					
Cold Start Battery Minimal Voltage	Lead Acid: Low DC Cut-Off Voltage+2Vdc Lithium >Low DC Cut-off Soc+10%					
High DC Recovery Voltage	58VDC					
High DC Cut-Off Voltage	AGM:60V, FLD:62V, USE or Li Mode: C.V. Voltage + 4.0V (Fault After 60 seconds)					
AC INPUT						
Nominal Voltage	240VAC					
Bypass Voltage Range	Appliance Mode: 154~272Vac±5V / 164~262Vac±5V(Recover) UPS Mode: 184~272Vac±5V / 194~262Vac±5V(Recover)					
Utility Charge Voltage Range	Appliance Mode: 154V-260Vac / 164V-250Vac(Recovery) UPS Mode: 184V-260Vac / 194-250Vac(Recovery)					
Frequency Range	45-65Hz/ (47-63Hz Recovery)					
Maximum Charge Current	40A	50A	60A	70A	80A	100A
BYPASS & PROTECTION (Grid & Generator)						
Typical Transfer Time	10ms					
Overload Protection (SMPS Load)	Circuit breaker					
Output Short Circuit Protection	Circuit breaker					
AC Input Breaker	63A	63A	63A	80A	80A	80A
AC output Breaker	32A	32A	32A	63A	63A	63A
MECHANICAL SPECIFICATIONS						
Unit Dimensions (W*H*D)	540*360*218mm / 21.2*14.2*8.6"			650*380*225mm / 25.6*15*8.9"		
Packing Size (W*H*D)	740*550*460mm / 30*21*18"			810*540*410mm / 31.9*21.3*16.1"		
Net Weight	38kg/84lbs	41kg/90lbs	45kg/99lbs	64kg/141lbs	66kg/145lbs	75kg/165lbs
Gross Weight	53kg/116lbs	55kg/121lbs	59kg/130lbs	84kg/185lbs	86kg/190lbs	95kg/210lbs
OPERATING ENVIRONMENT						
Operation Temperature Range	0°C to 50°C / 32°F to 122°F					
Storage Temperature	-20°C to 60°C / -4°F to 140°F					
Nominal Altitude	<1000m. The output will be de-rated by about 5% with altitude increase of every 500 meters.					

Product Label for [M6048DUL](#) & [M12048DUL](#) Models



PV Off-grid Inverter

Model #: M6048DUL

Battery Mode:

Battery Input: 48VDC, 150A
 Battery Type: Lead-Acid / Lithium
 Max Continuous Output Power: 6000VA/6000W
 AC Output: 120/240VAC,50/60Hz,25A, 1Φ
 Output Power Factor: >0.7

AC Charger Mode:

AC Input : 240VAC, 45~65Hz, 37A, 1Φ
 Max AC Charge Current: 60A

Solar Charger Mode:

Max PV Input Voltage: 250VDC
 MPPT Voltage Range: 60~245VDC
 Number of Input Strings: 1
 Max PV Input Current: 80A
 Max Charge Current: 80A

Environment:

Altitude : <2000m
 Protection Class: I
 Display: LCD+LED
 Communication: WI-FI/GPRS (Optional)
 Operating Temperature Range:0°C~50°C/32°F~122°F

Conforms to UL STD. 1741

Certified to CSA STD. C22.2 No.107.1

Dongguan Sigineer Power Electrical Technology CO.,LTD.
 +8676982817616
 +8618998080464(WhatsApp)
www.sigineer.com Made In China



PV Off-grid Inverter

Model #: M12048DUL

Battery Mode:

Battery Input: 48VDC, 300A
 Battery Type: Lead-Acid / Lithium
 Max Continuous Output Power: 12000VA/12000W
 AC Output: 120/240VAC,50/60Hz,50A, 1Φ
 Output Power Factor: >0.7

AC Charger Mode:

AC Input : 240VAC, 45~65Hz, 70A, 1Φ
 Max AC Charge Current: 100A

Solar Charger Mode:

Max PV Input Voltage: 250VDC
 MPPT Voltage Range: 60~245VDC
 Number of Input Strings: 2
 Max PV Input Current: 60/60A
 Max Charge Current: 120A

Environment:

Altitude : <2000m
 Protection Class: I
 Display: LCD+LED
 Communication: WI-FI/GPRS (Optional)
 Operating Temperature Range:0°C~50°C/32°F~122°F

Conforms to UL STD. 1741

Certified to CSA STD. C22.2 No.107.1

Dongguan Sigineer Power Electrical Technology CO.,LTD.
 +8676982817616
 +8618998080464(WhatsApp)
www.sigineer.com Made In China



Appendix 2: M Series Inverter/Charger System Wiring Diagram

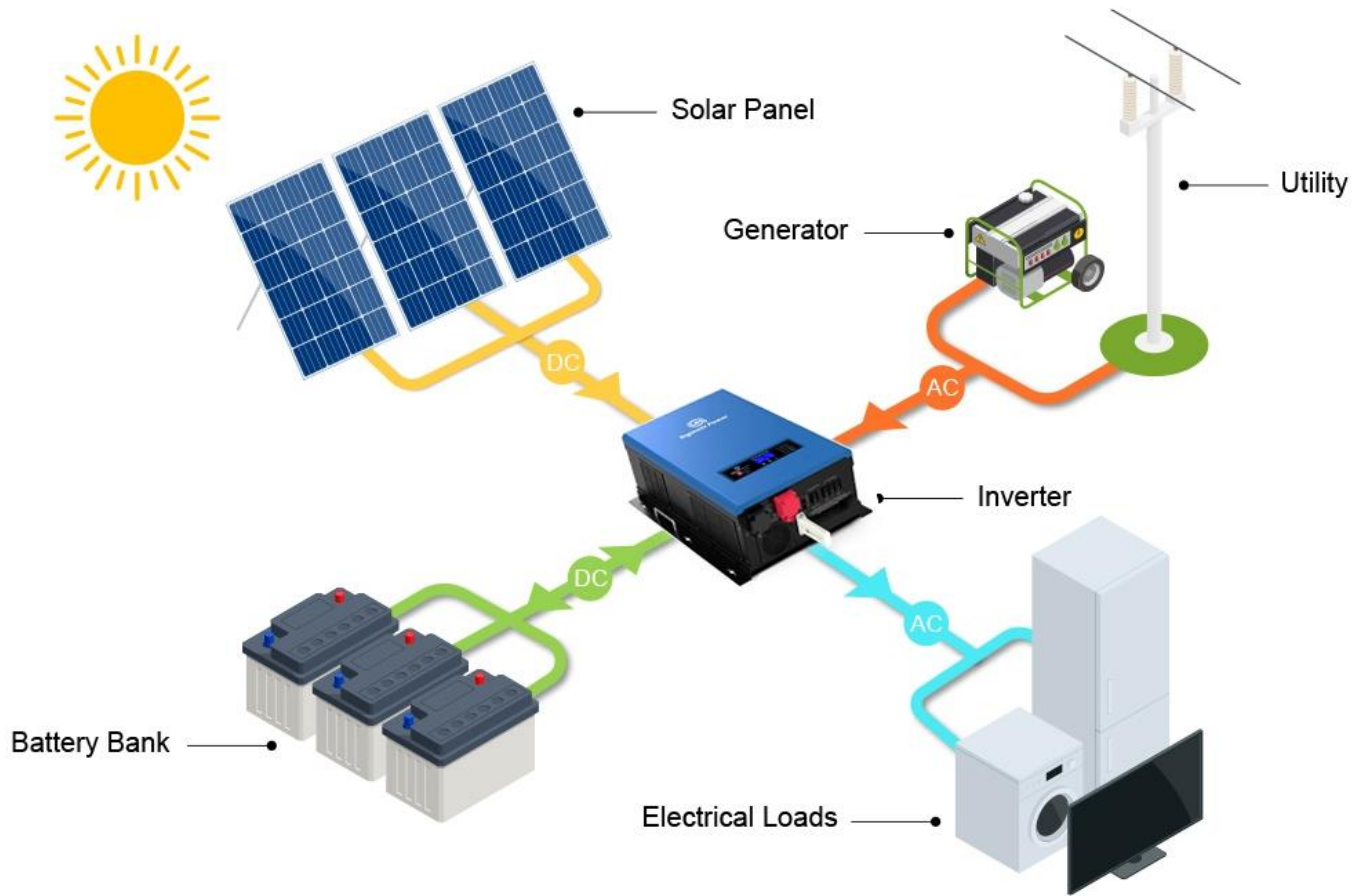

Appendix 3: UL1741 & CSA22.2 Certificates

The M4048DUL/M5048DUL/M6048DUL/M8048DUL/M10048DUL/M12048DUL inverter models are ETL listed to below standards:

- Inverters, Converters, Controllers and Interconnection System Equipment for use with Distributed Energy Resources [UL 1741:2010 Ed.2+R:16Sep2020]
- Power Conversion Equipment [CSA C22.2#107.1:2016 Ed.4]

The Sigineer Power ETL control number is 5023256.

Our ETL certificate can be verified in “Intertek Directory of Listed Products Search” from the below link:
<https://ramuk.intertekconnect.com/WebClients/ITS/DLP/products.nsf>

Please contact us at support@sigineer.com if you want to read our test report.

※Errors and omissions reserved. Specifications in this manual are subject to change without prior notice.

SAVE THIS MANUAL!
READ THIS MANUAL BEFORE INSTALLATION, IT
CONTAINS IMPORTANT SAFETY, INSTALLATION AND
OPERATING INSTRUCTIONS. KEEP IT IN A SAFE PLACE
FOR FUTURE REFERENCE.

Sigineer Power Limited
Email: info@sigineer.com
US Warehouse: 4415 S 32nd St, Phoenix AZ 85040
TEL: +86 769 82817616
WhatsApp: +8618998080464
www.sigineer.com